

SONY®



PlayStation®Portable

GB

CT

## Instruction manual

## 使用説明書

PSP-1006 K

PSP-1007 K



UMD™  
UNIVERSAL MEDIA DISC

MEMORY STICK

MEMORY STICK PRO Duo  
MEMORY STICK DUO

XMB™

2-549-103-63(1)

## Photosensitivity

A very small percentage of individuals may experience epileptic seizures when exposed to certain light patterns or flashing lights. Exposure to certain patterns or backgrounds on a television screen or while playing video games, including games played on the PSP™ system, may trigger an epileptic seizure in these individuals. Certain conditions may trigger previously undetected epileptic symptoms even in persons who have no history of prior seizures or epilepsy. If you, or anyone in your family, has an epileptic condition, consult your physician prior to playing. If you experience any of the following symptoms while playing a video game - dizziness, altered vision, eye or muscle twitches, loss of awareness, disorientation, any involuntary movement or convulsions - IMMEDIATELY discontinue use and consult your physician before resuming play.

## Radio waves

Radio waves may affect electronic equipment or medical devices (for example, pacemakers), which may cause malfunctions and possible injuries.

- If you use a pacemaker or other medical device, consult your physician or the manufacturer of your medical device before using the wireless networking feature.
- Keep the PSP™ system at least 23 cm (9 inches) away from a pacemaker or other medical devices when using the wireless networking feature.
- Do not use the wireless networking feature in the following locations:
  - Areas where its use is prohibited, such as in airplanes or hospitals. Abide by medical institution regulations when using the PSP™ system on their premises. Additionally, you may be violating air safety regulations punishable by fines by using the wireless networking feature in an airplane or by using the PSP™ system during takeoff or landing.
  - Crowded areas.
  - Areas near fire alarms, automatic doors and other types of automated equipment.
- Use caution when using the wireless networking feature in a vehicle, as radio waves may affect electronic equipment in some vehicles.





## GAME

→ page 40

- Playing games
- Managing saved data



## VIDEO

→ page 44

- Playing UMD™VIDEO
- Playing videos saved on a Memory Stick Duo™



## MUSIC

→ page 57

- Playing UMD™MUSIC
- Playing music saved on a Memory Stick Duo™



## PHOTO

→ page 70

- Displaying images saved on a Memory Stick Duo™
- Playing slideshows



## NETWORK

→ page 84

- Connecting to the Internet



## SETTINGS

→ page 87

- Adjusting PSP™ system settings
- Creating video, photo or network settings
- Connecting to devices using the USB connector

## Using the home menu

The basic operation of the PSP™ system starts from the home menu. Press the home button to display the home menu and use the directional buttons to navigate the horizontal and vertical icon bars.

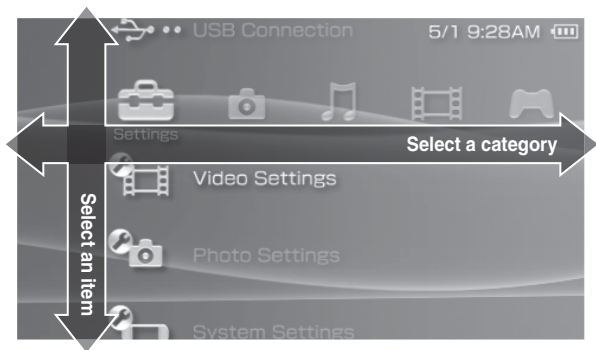

## Basic button operations

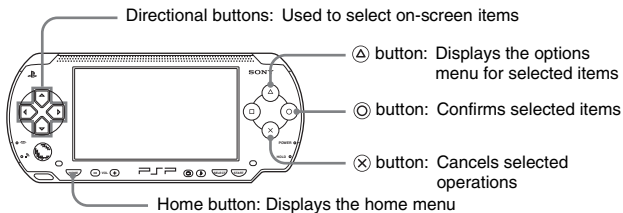

# Table of contents

WARNINGS .....	2
Precautions .....	9
Battery pack precautions .....	15

---

## ■ Preparation

Checking the package contents .....	16
Part names and functions .....	18
Preparing the PSP™ system for use .....	23
Connecting the headphones with remote control .....	26

---

## ■ Basic operations

Turning the PSP™ system on and off .....	27
Using sleep mode .....	29
Inserting a UMD™ .....	31
Inserting a Memory Stick Duo™ .....	32
Avoiding unintended operation of the PSP™ system .....	33
Using the sound button .....	34
Using the display button .....	36
Battery .....	37

---

## ■ Game

Playing a game .....	40
Game options menu .....	42
Copying and deleting saved data .....	43

---

## ■ Video

Watching a video .....	44
Using the control panel .....	46
Operating with PSP™ system buttons or the remote control .....	53
Video options menu .....	54
Saving videos on a Memory Stick Duo™ .....	55

---

## ■ Music

Listening to music .....	57
Using the control panel .....	60
Operating with PSP™ system buttons or the remote control .....	64
Music options menu .....	65
Transferring and saving music on a Memory Stick Duo™ .....	67

---

## ■ Photo

Viewing images .....	70
Using the control panel .....	71
Operating with PSP™ system buttons or the remote control .....	75
Photo options menu .....	76
Playing slideshows .....	78
Saving images on a Memory Stick Duo™ .....	82

---

## ■ Network

Connecting to the Internet .....	84
----------------------------------	----

---

## ■ Settings

Settings for the PSP™ system .....	87
Video Settings .....	89
Photo Settings .....	90
System Settings .....	91
Theme Settings .....	94
Date & Time Settings .....	95
Power Save Settings .....	96
Sound Settings .....	98
Security Settings .....	99
USB Connection .....	102
Network Settings .....	104
Network Update .....	111
How to use the keyboard .....	114

---

## ■ Additional information

PSP™ updates .....	117
Compatible media .....	119
Specifications .....	122
Troubleshooting .....	127
WARRANTY .....	135



# Precautions

Before using this product, carefully read this manual and retain it for future reference.

## Safety

This product has been designed with the highest concern for safety. However, any electrical device, if used improperly, has the potential for causing fire, electrical shock or personal injury. To help ensure accident-free operation, follow these guidelines:

- Observe all warnings, precautions and instructions.
- Regularly inspect the AC adaptor and AC power cord for damage and for dust build-up around the mains power plug or electrical outlet.
- Stop use, unplug the AC power cord from the electrical outlet and disconnect any other cables immediately if the device functions in an abnormal manner, produces unusual sounds or smells or becomes too hot to touch.
- Call the PSP™ service line at the number listed on your warranty card if the device does not operate properly.

## Use and handling

- Use in a well-lit area and keep the screen a safe distance from your face.
- Avoid prolonged use of the PSP™ system. To help prevent eyestrain, take a break of about 15 minutes during every hour of play.
- If you experience any of the following health problems, discontinue use of the system immediately. If symptoms persist, consult with your physician.
  - Dizziness, nausea, fatigue or symptoms similar to motion sickness
  - Discomfort or pain in a part of the body, such as eyes, ears, hands or arms
- Keep the system and accessories out of the reach of small children. Small children may swallow the Memory Stick Duo™ or wrap the cables/straps around themselves, which may inflict injury or cause an accident or a malfunction.
- Do not use the system while driving or riding a bicycle. Looking at the screen or operating the system while driving an automobile or riding a bicycle may result in a traffic accident.
- Take extra care when using the system while walking.
- Be careful not to pinch your fingers when closing the disc cover.

- Do not use the system or accessories near water.
- Use only attachments/accessories specified by the manufacturer.
- Do not use the headphones if they cause discomfort to your skin. If the supplied headphones cause discomfort to your skin, discontinue use immediately. If symptoms do not subside even after discontinuing use, seek medical attention.
- Do not expose the system or accessories to high temperatures, high humidity, or direct sunlight.
- Do not leave the system or accessories in a car with the windows closed (particularly in summer).
- Do not expose the system or accessories to dust, smoke or steam.
- Do not allow liquid or small particles to get into the system or accessories.
- Do not place the system or accessories on surfaces that are tilted, unstable or subject to vibration.
- Do not throw or drop the system or accessories, or subject the devices to strong physical shock. Handle the analog stick with care.
- Do not forcibly twist the PSP™ system or expose the system to strong physical shock during gameplay, as doing so can damage the system or cause the disc cover to open, ejecting the disc.
- Do not put heavy objects on the system or accessories.
- Do not touch or insert foreign objects into the connectors of the system or accessories.
- Do not place the system close to items with a magnetic strip, such as credit cards.
- Do not touch the system or AC adaptor for an extended period of time while in use. Depending on the conditions of use, the system or AC adaptor may reach temperatures of 40°C/104°F or more. Extended contact under these conditions may cause low-temperature burns\*.

\* Low-temperature burns are burns that occur when the skin is in contact with objects of relatively low temperatures (40°C or more/104°F or more) for an extended period of time.

## **AC adaptor and AC power cord use**

- Do not touch the mains power plug of the AC power cord with wet hands.
- Do not touch the AC power cord, AC adaptor or the system, if connected to an electrical outlet, during an electrical storm.
- Do not use a power source other than the supplied battery pack, AC adaptor and AC power cord.

- Do not allow dust or foreign matter to build up around the system or accessory connectors. If there is dust or foreign matter on the system's connectors or the AC power cord, wipe it off with a dry cloth before connecting. Dust or other matter on the connectors can result in fire or electrical shock.
- Unplug the AC power cord from the electrical outlet and remove the battery pack from the system before cleaning or when you do not intend to use the system for an extended period of time.
- Protect the AC power cord from being walked on or pinched particularly at plugs, convenience receptacles and the point where they exit from the system.
- When disconnecting the AC power cord, hold it by the plug and pull straight out from the electrical socket. Never pull by the cord and do not pull at an angle.
- Do not use the system to play games or video when the system is covered with any type of fabric. If you want to pause or temporarily store the system while playing games or video, put the system in sleep mode before placing it in the pouch. Also do not use the AC adaptor when covered with fabric. This may help to avoid overheating.
- Do not connect the AC power cord to a voltage transformer or inverter. Connecting the AC power cord to a voltage transformer for overseas travel or an inverter for use in an automobile may cause heat to build up in the AC adaptor and may cause burns or a malfunction.

## **LCD screen**

- Red, blue or green spots (bright spots) or black spots (dark spots) may appear in certain locations on the LCD screen. The appearance of such spots is a normal occurrence associated with LCD screens and is not a sign of a malfunction. LCD screens are made using highly precise technology. However, a very small number of dark pixels or continuously lit pixels exist on each screen. Also, a distorted image may remain on the screen for several seconds after the system has been turned off.
- Direct exposure to sunlight may damage the system's LCD screen. Be careful when using the system outdoors or near a window.
- When using the system in a cold environment, you may notice shadows on the graphics or the screen may appear darker than usual. This is not a malfunction, and the screen will return to normal when the temperature goes up.
- Do not leave still images displayed on the screen for an extended period of time. This may cause a faint image to be left permanently on the screen.

## Memory Stick Duo™

For best results, follow these guidelines:

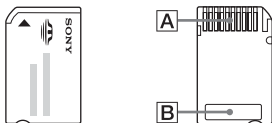

- Do not touch the connector area (A) with your hands or with metal objects.
- Do not press hard when writing on the memo area (B).
- Do not insert a Memory Stick Duo™ into a device designed to accept only standard-size Memory Stick™ media.
- Do not use or store a Memory Stick Duo™ in the following:
  - Places subject to high temperatures, such as in a hot vehicle
  - Locations exposed to direct sunlight
  - Locations that are very humid or conducive to corrosion
- Use the supplied case to carry or store the Memory Stick Duo™.
- When using Memory Stick Duo™ media without an erasure prevention switch, take care not to overwrite or delete data by accident. If your Memory Stick Duo™ media has an erasure prevention switch, you can prevent data from being saved, edited, or deleted by setting the switch in the LOCK position.

### ■ Recorded data

Do not use the Memory Stick Duo™ in the following ways, as doing so may result in data loss or corruption:

- Removing the Memory Stick Duo™ or turning off the system while it is loading or saving data or being formatted.
- Using it in a location that is exposed to static electricity or electrical interference.

If, for any reason, software or data loss or corruption occurs, it is usually not possible to recover the software or data. It is recommended that you regularly back up software and data. Sony Computer Entertainment Inc. and its subsidiaries and affiliates will not be held liable for any damages or injury in the case of software or data loss or corruption.

In accordance with copyright law, no recorded data may be used for purposes other than personal enjoyment without permission from the copyright holder.

## Pouch and hand strap

- If you want to pause or temporarily store the system while playing games or video, put the system in sleep mode before placing it in the pouch. This may help to avoid overheating.
- Put both the PSP™ system and the remote control in hold mode to help prevent unintended operation.
- Keep the pouch and hand strap out of the reach of small children.

GB

## Never disassemble the system or supplied accessories

Use the PSP™ system and accessories according to the instructions in this manual. No authorization for the analysis or modification of the system, or the analysis and use of its circuit configurations, is provided. Disassembling will void the system warranty. Additionally, there is a risk of fire, electrical shock or malfunction. The LCD screen, in particular, contains dangerous, high-voltage parts, and the laser beam for reading UMD™ may cause visual impairment if exposed directly to the eyes.

## Overseas use

Depending on the country, there are limitations on the use of certain types of radio waves. In some cases, use of the system may lead to a fine or other penalty.

## Moisture condensation

If the PSP™ system or UMD™ is brought directly from a cold location to a warm one, moisture may condense on the lens inside the system or on the UMD™. Should this occur, the system may not operate properly. In this case, remove the UMD™ and turn off and unplug the system. Do not put the UMD™ back in until the moisture evaporates (this may take several hours). If the system still does not operate properly, contact the PSP™ service line at the number listed on your warranty card for assistance.

## **UMD™ handling**

- Do not touch the opening on the rear of the disc (recorded surface of the disc) with your fingers.
- Do not allow dust, sand, foreign objects or other types of dirt to get on the disc.
- If the UMD™ becomes dirty, gently wipe the exterior and recorded surfaces of the UMD™ using a soft cloth. Do not use solvents or other chemicals.

## **Cleaning**

For safety reasons, unplug the AC power cord from the electrical outlet and remove the battery pack from the system before cleaning.

### **■ Cleaning the exterior surface**

Wipe gently with a damp cloth, and then dry the surface. Do not use solvents or other chemicals to clean the exterior of the PSP™ system.

### **■ Cleaning the LCD screen**

Wipe gently with a soft cloth.

### **■ Cleaning the connectors**

- Do not use when the connectors of the system, AC adaptor or the AC power cord are not clean. Remove the dirt with a dry cloth or cotton swab. If used when dirty, the flow of electrical current may be obstructed.
- If the headphones or remote control connectors become dirty, this could cause noise or interruptions in sound. Wipe the connectors with a dry, soft cloth to keep in clean condition.

# Battery pack precautions

## Warnings

### **Do not handle a damaged or leaking battery pack.**

Contact with the material can result in injury or burns to the eyes or skin. Even if foreign substances are not immediately visible, chemical changes in the material can result in injuries occurring at a later time.

If you come into contact with material from a leaking battery pack, take the following actions:

- If the material gets into the eyes, do not rub. Immediately flush the eyes with clean water and seek medical attention.
- If the material comes into contact with the skin or clothes, immediately rinse the affected area with clean water. Consult your physician if inflammation or soreness develops.

### **Handle the battery pack with care.**

The battery pack may explode or present a fire or chemical burn hazard if it is not handled carefully.

- Do not allow the battery pack to come into contact with fire or subject it to extreme temperatures such as in direct sunlight, in a vehicle exposed to the sun or near a heat source.
- Do not cause the battery pack to short-circuit.
- Do not disassemble or tamper with the battery pack.
- Prevent damage to the battery pack. Do not carry or store the battery pack with metal items such as coins or keys. If damaged, discontinue use.
- Do not throw or drop the battery pack or subject it to strong physical shock.
- Do not put heavy objects on or apply pressure to the battery pack.
- Do not allow the battery pack to come into contact with liquids. If it becomes wet, discontinue use until it is completely dry.
- Keep the battery pack out of the reach of small children.
- If the PSP™ system will not be used for an extended period of time, remove the battery pack and store it in a cool, dry place out of the reach of children.
- Use only the supplied battery pack or a replacement marked for use with the PSP™ system.
- Use only the designated AC adaptor to charge the battery pack.

# Checking the package contents

Check that you have all of the following items. If any items are missing, contact the PSP™ service line at the number listed on your warranty card for assistance.

- PSP™ (PlayStation®Portable)

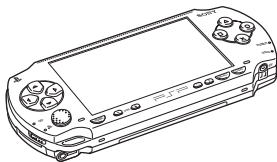

- Battery pack



- Headphones with remote control

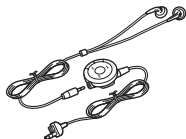

- AC adaptor



- AC power cord (with 3-pin converting adaptor attached) (supplied with PSP-1006 K)



- Memory Stick Duo™ (32 MB)

- Hand strap

- Pouch

- Cloth

- Printed materials

- AC power cord (supplied with PSP-1007 K)





## Removing the 3-pin converting adaptor (PSP-1006 K only)

Electrical outlet configuration may vary depending on the region of use. If the plug on the supplied AC power cord does not match the electrical outlet, loosen the screw and remove the converting adaptor.

3-pin converting adaptor

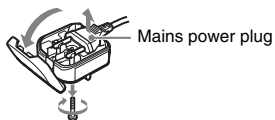

GB

Preparation

# Part names and functions

## System front

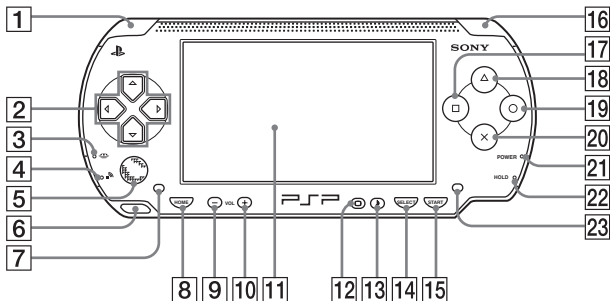

**1 L button**

**2 Directional buttons**

**3 Memory Stick Duo™ access indicator**

Lights up when saving and loading data

**4 WLAN access indicator**

Lights up when using the wireless networking feature

**5 Analog stick**

Can be used with games that support analog operation

**6 Strap holder**

Attach as shown in the diagram.

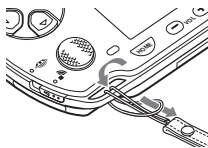

**7 Left speaker**

**8 Home button**

Displays the home menu

**9 Volume - button**

Turns the volume down

**10 Volume + button**

Turns the volume up

- 11 LCD screen**
- 12 Display button**  
Adjusts screen brightness  
(▶▶ page 36)
- 13 Sound button**  
Adjusts the tone (▶▶ page 34)
- 14 Select button**
- 15 Start button**
- 16 R button**
- 17 □ button**
- 18 ▲ button**
- 19 ○ button**
- 20 × button**
- 21 Power indicator**  
Lights up, flashes or changes color to indicate system status  
(▶▶ page 27)
- 22 Hold indicator**  
Turns yellow when in hold mode  
(▶▶ page 33)
- 23 Right speaker**

## System rear

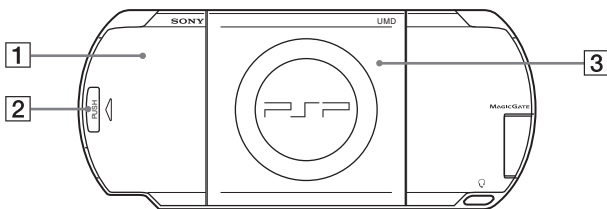

- 1 Battery cover**
- 2 Push button**
- 3 Disc cover**

## System top

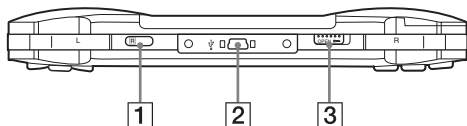

1 IR port

3 Open latch

2 USB connector

## System bottom

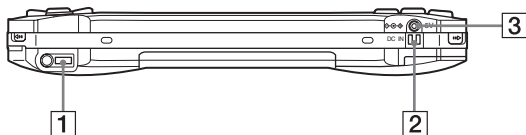

1 Headset connector

3 DC IN 5V connector

2 Charging terminals

## System left side

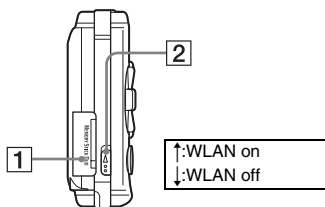

**1** Memory Stick Duo™ slot

**2** WLAN switch

Turns on the wireless networking feature

## System right side

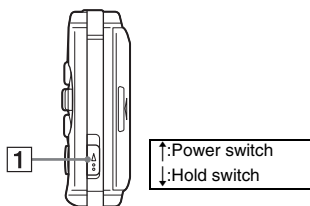

**1** Power/hold switch

Turns the system on and off, puts in sleep mode (\*\*► pages 27, 29) and locks the system buttons (\*\*► page 33)

## Headphones with remote control

### Remote control front

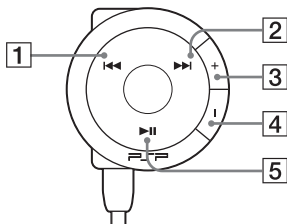

- 1 **◀◀ button**
- 2 **▶▶ button**
- 3 **Volume + button**  
Turns the volume up
- 4 **Volume - button**  
Turns the volume down
- 5 **▶|| button**

### Remote control side

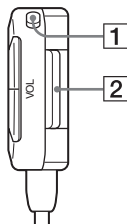

- 1 **Hold switch**  
Locks the operation of the remote control. Note that this button does not lock the buttons of the PSP™ system.
- 2 **Clip**

# Preparing the PSP™ system for use

Before using the PSP™ system for the first time after purchase, you must follow these steps to charge the battery.

## Getting started 1: Inserting the battery pack

GB

Preparation

### 1 Remove the battery cover.

Hold down the push button and slide the battery cover open.

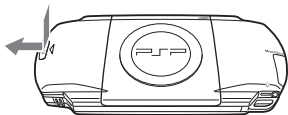

### 2 Insert the battery pack.

Align the bottom surface of the battery pack with the system to attach.

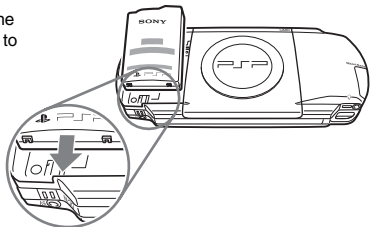

### 3 Replace the battery cover.

- ② Slide the battery cover in the direction of the arrow until it locks firmly into place.

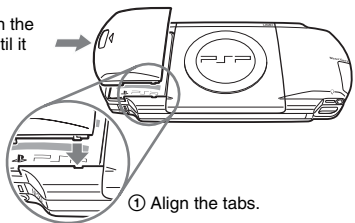

## Getting started 2: Charging

### ⚠ Caution

- The socket-outlet shall be installed near the equipment and shall be easily accessible.
- Do not plug the AC power cord for the PSP™ system into an electrical outlet until you have made all other connections.

### 1 Plug the AC power cord into the AC adaptor.

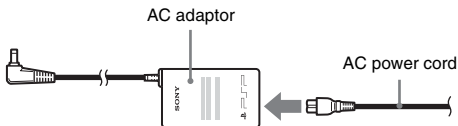

### 2 Connect the AC adaptor to the DC IN 5V connector on the system bottom.

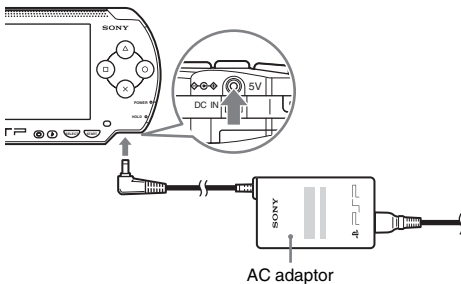



### 3 Plug the AC power cord into an electrical outlet.

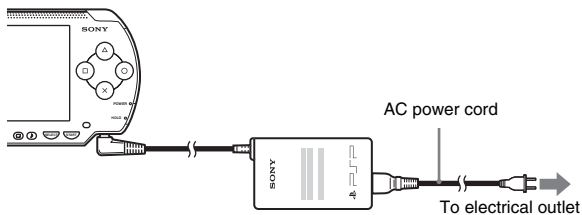

The power indicator lights up in orange, indicating that charging has begun. The power indicator will turn off when the battery is fully charged.

### 4 Unplug the AC power cord from the electrical outlet and disconnect the AC adaptor from the system.

#### Hint

For information on how to charge the battery, see "Battery" (••► page 37).

## Getting started 3: Initial setup

### 1 Turn on the PSP™ system (••► page 27).

The power indicator lights up in green, and the initial setup screen is displayed.

### 2 Follow the on-screen instructions to make settings for system language, time zone, date and time and nickname.

When you have completed initial setup, the home menu (••► page 5) is displayed.

#### Hints

- See "How to use the keyboard" (••► page 114) for information on how to enter characters.
- Settings made during initial setup can be changed in  (Settings). See "System Settings" (••► page 91) and "Date & Time Settings" (••► page 95) for details.

# Connecting the headphones with remote control

## 1 Connect the headphones to the PSP™ system.

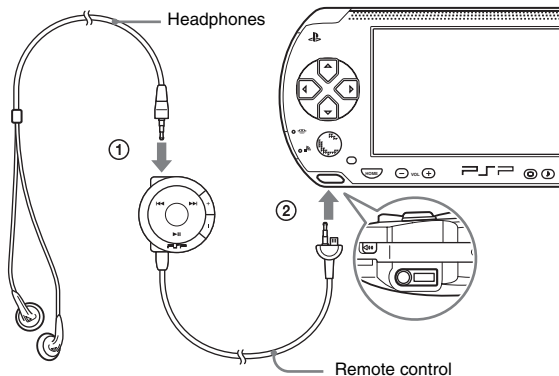

- 1 Plug the headphones into the remote control.
- 2 Plug the headphones into the headset connector on the system bottom.

### Hint

The remote control is exclusively for use with the PSP™ system and cannot be used with other devices. Also, remote controls supplied with other devices cannot be used to operate the PSP™ system.

# Turning the PSP™ system on and off

## Turning the system on

- 1 Slide the power/hold switch up.

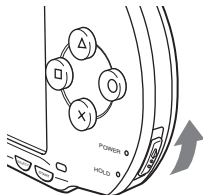

The power indicator lights up in green, and the home menu is displayed.

### Hints

- If the PSP™ system is turned on with a UMD™ inserted, the UMD™ will begin playback automatically.
- The system can be used with the AC adaptor connected. In this case, charging will begin automatically. The power indicator lights up in orange while charging.
- Do not use the PSP™ system with the AC adaptor when the battery pack is not inserted in the system. If the AC adaptor is disconnected suddenly, it may result in damage to the system.

## Power indicator

The color and condition (solid or flashing) of the light indicates system status.

Solid green	Power on
Solid orange	Charging
Flashing green	Charge level is low
Light off	Power off/in sleep mode

## Turning the system off

- 1 Hold the power/hold switch in the up position for more than three seconds.**

The power indicator flashes and then turns off, indicating that the system is turned off.

## Using sleep mode

If the PSP™ system is switched to sleep mode, the software that is playing will be paused. When sleep mode is cleared, you can begin playback from the point you entered sleep mode.

### Notices

- Do not put the system into sleep mode while the Memory Stick Duo™ access indicator is on. This may cause data loss or corruption.
- If the battery runs out while in sleep mode, when you clear sleep mode, the system will not return to the screen that was displayed before entering sleep mode. It is recommended that you save game data before you put the system into sleep mode.

## Putting into sleep mode

- 1** With the system turned on, slide the power/hold switch up.

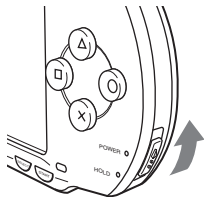

The power indicator flashes and then turns off, and the system enters sleep mode.

### Hint

Some software cannot be put into sleep mode.

## Clearing sleep mode

### 1 Slide the power/hold switch up again.

Sleep mode is cleared.

#### Hints

- You can also clear sleep mode by pressing the ►|| (play/pause) button of the remote control, if the system was put into sleep mode during music or video playback.
- After clearing sleep mode with video or music content, you can resume playback from the point where the system entered sleep mode by following the steps below.

Video	With the icon for the video selected, do any of the following: <ul style="list-style-type: none"><li>- Press the start button or © button</li><li>- Press the ►   button of the remote control</li><li>- Select "Play" from the options menu (►► page 54)</li></ul>
Music saved on a Memory Stick Duo™	With the icon for the Memory Stick Duo™ selected, do any of the following: <ul style="list-style-type: none"><li>- Press the start button</li><li>- Press the ►   button of the remote control</li><li>- Select "Play" from the options menu (►► page 65)</li></ul>

# Inserting a UMD™

## Notice

Do not eject a UMD™ during playback.

### 1 Slide the open latch on the PSP™ system top.

The disc cover opens.

### 2 Insert a UMD™.

With the disc label facing the system rear, slide the UMD™ in the direction of the arrow until it is fully inserted.

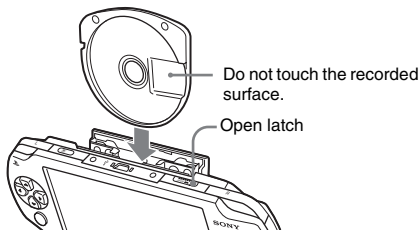

### 3 Close the disc cover.

## Ejecting the UMD™

Slide the open latch on the system top to open the disc cover.

### Hint

When ejecting, hold the PSP™ system in an upright position (as shown in the diagram above).

# Inserting a Memory Stick Duo™

## Warning

Keep Memory Stick Duo™ media out of the reach of small children, as the media could be swallowed by accident.

## 1 Open the slot cover and insert the Memory Stick Duo™.

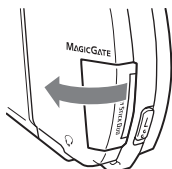

Open the slot cover in the direction of the arrow.

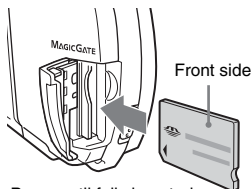

Press until fully inserted.

## Ejecting the Memory Stick Duo™

Open the slot cover and press the Memory Stick Duo™ in the direction of the arrow to eject.

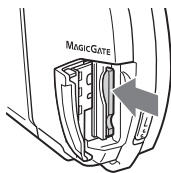

## Notice

When the Memory Stick Duo™ access indicator is lit, the PSP™ system is saving or loading data. Do not eject the Memory Stick Duo™, turn off the system or put the PSP™ system into sleep mode while the indicator is lit. If you do, it may cause data loss or corruption.

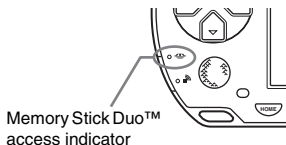



# Avoiding unintended operation of the PSP™ system

- 1 Slide the power/hold switch down.**

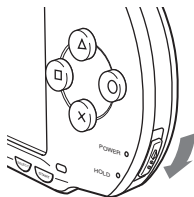

The switch locks into place.

The hold indicator turns yellow, indicating that the system buttons are locked.

## Clearing hold mode

Slide the power/hold switch to its original position.

## Using the sound button

The sound button is used to adjust the tone and to mute the sound for audio playback and for key tones.

### Adjusting the tone

#### 1 Press the sound button.

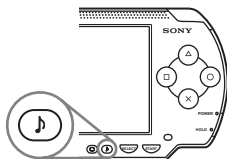

Each time you press the button, the tone changes as follows:

HEAVY	Strengthens both bass and treble to produce an intense sound
POPS	Strengthens the mid-range. Ideal for vocals
JAZZ	Strengthens both bass and treble to produce a balanced sound
UNIQUE	Strengthens bass, treble and mid-range sound
OFF	Normal tone

#### Hint

Tone can only be adjusted when using the headphones. Also, note that the tone setting is temporarily set to "OFF" during gameplay.

### Turning off the sound (mute)

#### 1 Hold down the sound button for more than one second.

The sound will be muted.

## Clearing mute

Muting can be turned off by the following methods:

- Pressing the sound button.
- Pressing the volume + or volume - button on the system front or on the remote control.

## Using the display button

The display button is used to adjust screen brightness.

### Adjusting screen brightness

#### 1 Press the display button.

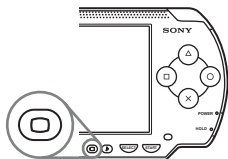

Each time you press the button, the display changes as follows:

Level 1	Darker	
Level 2	↓	
Level 3		
(Level 4)		Brighter

#### Hint

Level 4 can be selected only while plugged in using the AC adaptor.

### Turning off the backlight

#### 1 Hold down the display button for more than one second.

The backlight will turn off and the screen will go blank.

If you press any of the system buttons, the screen will be displayed again.

# Battery

## Battery charge level

The battery charge level is displayed on the screen.

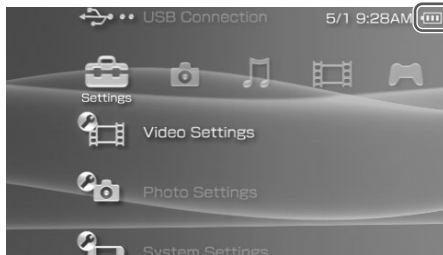

Battery charge level

GB

Basic operations

## Estimating the remaining battery power

	There is plenty of power left.
	The battery is getting low.
	The battery has almost run out.
	No battery power remains. The power indicator flashes green. Recharge the battery.

### Hints

- If the power indicator flashes green, save game progress and recharge the battery. If the battery runs out before you save, game progress will be lost.
- The charge level display may vary slightly from the actual charge level, depending on the usage conditions and environmental factors, such as temperature. If the display is not correct, use the battery pack until it is completely out of power and then recharge. Note that the display may not be accurate in the following conditions:
  - if the battery is used for extended periods in conditions of high temperature
  - if the battery is not used for a long time after recharging
  - if the battery has been recharged many times

- Battery charge level can also be checked in "Battery information" under "System Settings" (\*\*▶ page 92).
- If the PSP™ system is left unused after the battery runs out, the date and time settings may be reset. If this occurs, the date and time setting screen will be displayed the next time the system is turned on.
- The battery cannot be recharged when the WLAN feature is in use.

## Estimated battery duration

Game	Approximately 3 - 6 hours* <sup>1</sup>
Video playback	Approximately 3 - 5 hours* <sup>2</sup>

\*1 Based on tests conducted using the supplied battery pack, with the system in single player mode, with headphones with remote control in use, and with wireless LAN not in use.

\*2 Based on tests conducted using variables of system speakers versus headphones, volume level and screen brightness level.

### Hint

Battery duration may vary depending on the type of content being played or usage conditions such as screen brightness and environmental factors. As battery ages, anticipate lower battery duration.

## Estimating the battery charge time

When using the supplied battery pack, it takes approximately 2 hours and 20 minutes to fully charge the battery using the AC adaptor after the battery has run out.

### Hints

- Charge in a temperature of 10° C to 30° C/50° F to 86° F. Charging may not be as effective in other environments.
- Charging may take longer when the system is turned on during charging.

## Battery pack life

The battery pack has a limited lifespan. Battery duration will decrease with repeated usage and age. If the battery duration becomes extremely short, it may be time to replace the battery pack.

### Hint

The battery pack lifespan varies depending on how it is stored, the conditions of use and environmental factors, such as temperature.

## Replacing the battery pack

For safety reasons, turn off the system and remove the power cord from the electrical outlet before replacing the battery pack. Also read "Battery pack precautions" (►► page 15) before handling the battery pack.

### Hint

If the system is left unused after the battery pack has been removed, the date and time settings may be reset. If this occurs, the date and time setting screen will be displayed the next time the PSP™ system is turned on.

## Storing the battery pack

When the system will not be used for an extended period of time, remove the battery pack from the system. Store the battery pack in a cool, dry place out of the reach of children.

## Playing a game

**1** Select  from the home menu.

**2** Insert a UMD™ (→ page 31).

The UMD™ icon is displayed.

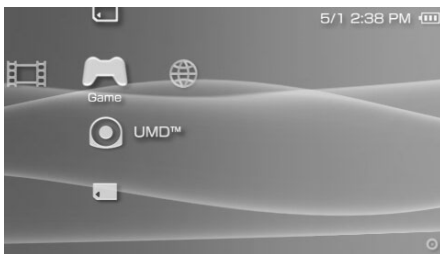





**3** With the game icon selected, press the  button.

The game starts.





### Icons displayed under Game

In addition to playing games, the following features are available under Game.

	Game Sharing	You can use ad hoc mode (→ page 104) to receive game data from another PSP™ system. For details, refer to the software manual supplied with the game.
	Saved Data Utility	You can copy, delete or view information about saved data on a Memory Stick Duo™ (→ page 43).
	UMD™	You can play games. If you select the UMD™ icon, the thumbnail for the game is displayed.
	PSP™ Update	You can update the system software of the PSP™ system. This icon is displayed only when a UMD™ that contains update data is inserted (→ page 117).
	Memory Stick™	You can perform an update by accessing the update data saved on a Memory Stick Duo™ (→ page 117).



## Hints

- If  (Restricted Content) is displayed when you select the  (UMD™) icon, parental control restrictions have been set on the system. You must enter the password as described below to access the game. See "Parental Control Level" (▶▶ page 100) for details.
  - 1** Select , and then press the .
  - 2** Enter the 4-digit password using the directional buttons, and then press the .
- If you press the home button during gameplay, you can check the remaining battery power.
- Title names and thumbnail images used in this manual are not of actual products.

## Quitting a game

- 1 Press the home button while playing a game.**

The message "Do you want to quit the game?" is displayed.
- 2 Select "Yes", and then press the  button.**

The game ends and the home menu is displayed.

# Game options menu

You can view game information or copy or delete saved data by displaying the options menu.

## 1 Select an icon, and then press the $\triangle$ button.

The options menu is displayed.

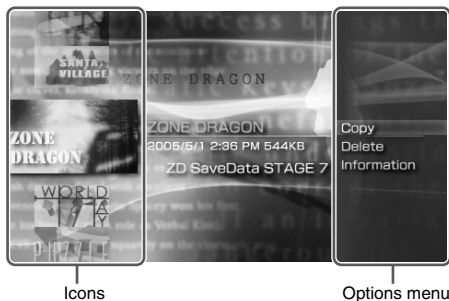

## 2 Select a menu item, and then press the $\odot$ button.

### Closing the options menu

Press the  $\triangle$  button or the  $\times$  button.

### List of options

The options menu items available vary depending on the icon selected.





Start	Starts a game or update data
Copy	Copies the saved data on a Memory Stick Duo™ to another Memory Stick Duo™ (**▶ page 43)
Delete	Deletes the data on a Memory Stick Duo™
Information	Displays information about the selected icon

## Copying and deleting saved data

You can copy or delete saved game data that is saved on a Memory Stick Duo™ using the saved data utility.

### Copying saved data

You can copy saved data to another Memory Stick Duo™. It is recommended that important data be copied as a backup.

- 1** Select , and then press the  button.
- 2** Select the saved data you want to copy, and then press the  button.  
The options menu is displayed.
- 3** Select "Copy", and then press the  button.
- 4** Follow the on-screen instructions.

### If there is not enough space available

Delete data in the destination Memory Stick Duo™ or replace it with another Memory Stick Duo™. If you display the options menu (→ page 42), you can delete saved data or check the amount of free space available.

#### Hint

Depending on the type of Memory Stick Duo™ used, the file size displayed for the same data item may vary.

### Deleting saved data



You can delete saved data on a Memory Stick Duo™ by selecting "Delete" in step 3 of "Copying saved data".

## Watching a video

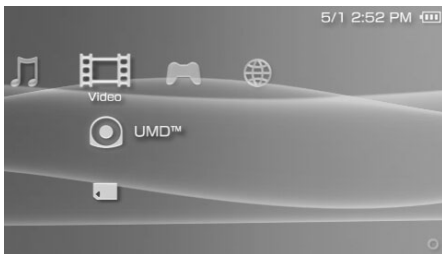

You can watch UMD™VIDEO and videos saved on a Memory Stick Duo™.

- 1 Select  from the home menu.**
- 2 Insert a UMD™ or Memory Stick Duo™ (→ pages 31, 32).**  
An icon for the inserted media is displayed.







- 3 Select the icon, and then press the  button.**  
UMD™VIDEO playback begins. If you select , icons for each video data item will be displayed. Select the video that you want to play, and then press the  button.

## Icons displayed under Video

	UMD™	You can play UMD™VIDEO. If you select the icon, a thumbnail for the video is displayed.
	Memory Stick™	You can play video saved on a Memory Stick Duo™.

### Hints

- If  (Restricted Content) is displayed when you select the  (UMD™) icon, parental control restrictions have been set on the system. Enter the password as described below to access the video. See "Parental Control Level" (\*\*▶ page 100) for details about the parental control feature.
  - 1 Select  (Restricted Content), and then press the  button.
  - 2 Enter the 4-digit password using the directional buttons, and then press the  button.
- If you press the home button or select button during video playback, the home menu will be shown on the screen while the paused image of the video is displayed. If you press the button again, the home menu is cleared.
- You can adjust the tone or mute the sound using the sound button (\*\*▶ page 34).
- For a list of file types that can be played on the PSP™ system, see "Files that can be played" (\*\*▶ page 121).

## Stopping playback

### 1 Press the button during video playback.

The video will stop.

### Hint

In most cases, the next time you play the video, playback will resume from the previous stopping point.

## Playing a video from the beginning

If you want to play a UMD™VIDEO from the beginning, select "Play from Beginning" in the options menu (\*\*▶ page 54), and then press the  button.

# Using the control panel

You can perform the following operations using the on-screen control panel.

## Notice

Depending on the UMD™VIDEO, playback conditions may be set in advance by the software developer. In such cases, certain options may not be available, even if you follow the instructions in this manual.

### 1 Press the $\triangle$ button during video playback.

The control panel is displayed.



### 2 Select an icon, and then press the $\odot$ button.

## Clearing the control panel

Press the  $\triangle$  button or the  $\otimes$  button.

## List of operations

The icons displayed when playing a UMD™VIDEO are different from those displayed when playing a video saved on a Memory Stick Duo™.

Icon	Description
 Menu	Displays the UMD™VIDEO menu

Icon		Description
	Go To	Plays from a specified chapter* or time (**▶ page 49)
	Audio Options	Switches between available audio options for UMD™VIDEO recorded with multiple audio tracks
		Switches between Left, Right, and Left + Right audio output for video saved on a Memory Stick Duo™
	Angle Options	Switches between available viewing angles for UMD™VIDEO recorded with multiple angles
	Subtitle Options	Switches between available subtitle options for UMD™VIDEO that include subtitles
	UMD™Video Volume	Boosts the volume of the UMD™VIDEO (**▶ page 50)
	Screen Mode	Changes the size of the image displayed on the screen (**▶ page 49)
	Display	Displays the playback status and related information (**▶ page 48)
	Help	Displays the functions that can be performed using the PSP™ system buttons
	Previous	Returns to the previous chapter of a UMD™VIDEO during playback
	Return to Beginning	Returns to the beginning of a video saved on a Memory Stick Duo™ during playback
	Next	Skips to the next chapter*
	Fast Reverse/ Fast Forward	Accelerates playback (reverse or forward) on the screen to help locate a particular scene (**▶ page 50)
	Slow Motion	Plays a scene in slow motion (**▶ page 51)
	Frame Advance	Plays a scene one frame at a time
	Play	Starts playback
	Pause	Pauses playback

Icon		Description
■	Stop	Stops playback
A-B	A-B Repeat	Plays a specified section repeatedly (**▶ page 52)
	Repeat	Plays the video repeatedly (**▶ page 51)
<b>CLEAR</b>	Clear	Clears the Repeat setting

\* This operation cannot be performed during playback of video saved on a Memory Stick Duo™.

## Viewing playback status and related information

- 1 Select from the control panel during playback, and then press the button.

The playback status of the video is displayed.



## Clearing display

Select from the control panel, and then press the button.



## Hint

The items displayed when playing a UMD™VIDEO are different from those displayed when playing a video saved on a Memory Stick Duo™.

## Changing the Screen Mode

Changes the size of the viewable image on the screen.

GB

Video

- 1 Select  from the control panel, and then press the  button.**

Each time the  button is pressed, the Screen Mode will change as follows:



Normal	The image is adjusted to fit the PSP™ system's screen size.
Zoom	The image is shown at the full screen size without changing proportions, while cutting off the top and bottom or left and right areas.
Full Screen	The image is shown in the full screen size by changing proportions and zooming in horizontally and vertically.
Original	The image is shown in the original size.
4:3	An image recorded in 16:9 aspect ratio is displayed in 4:3.

## Hint

Depending on the video being played, the Screen Mode may remain unchanged.

## Playback from a selected scene

You can play from a specified chapter or time.

- 1 Select  from the control panel, and then press the  button.**
- 2 Using the directional buttons, specify the number for the chapter or time and then press the  button.**

Chapter	Specifies the chapter number*
XX:XX:XX	Specifies the elapsed time

\* You cannot use this feature when playing video saved on Memory Stick Duo™.

## Adjusting the UMD™ Video volume

The volume can be adjusted if the audio output level of the UMD™ is low.

- 1 Select  from the control panel, and then press the  button.**

Each time you press the  button, the volume will change as follows:

+1	Raises the volume
+2	Raises the volume (maximum)
Normal	Usually select this setting.



### Hint

The volume setting will be cleared if the UMD™ is ejected. The volume can be permanently set to a higher level under Video Settings (\*\*▶ page 89).



## Fast Reverse/Fast Forward

- 1 During playback, select  or  from the control panel, and then press the .**

## Returning to normal playback

Select  from the control panel, and then press the .

### Hint

While using Fast Reverse or Fast Forward, select  or  from the control panel, and then press the  button to switch between three speed options.





## Slow playback

- 1 During playback, select  from the control panel, and then press the  button.

## Returning to normal playback

Select  from the control panel, and then press the  button.

### Hint

Selecting  or  from the control panel while playback is paused, and then pressing the  button, will also start slow playback. If  (Fast Forward) is selected, slow playback will continue only as long as the  button is held.

## Playing repeatedly

You can play the entire disc or a chapter repeatedly.

- 1 Select  from the control panel, and then press the  button.

Each time you press the  button, the repeat mode changes as follows:

Disc Repeat	Plays the entire disc repeatedly
Chapter Repeat	Plays the specified chapter repeatedly
Repeat Off	Ends repeat playback

### Hints

- You can also stop repeated playback by pressing the  button after selecting **CLEAR** from the control panel.
- The only repeat options for videos saved on a Memory Stick Duo™ are Repeat On and Repeat Off.

## Playing a section of video repeatedly A-B

You can specify a section of video that you want to play repeatedly.

- 1 During playback, select A-B from the control panel and then press the  button at the beginning of the section to be repeated.**

The starting point, point A, is set.

- 2 Press the  button at the end of the section to be repeated.**









The ending point, point B, is set and the specified section begins to play repeatedly.

### Clearing A-B Repeat

Select A-B or **CLEAR** from the control panel, and then press the  button.

# Operating with PSP™ system buttons or the remote control

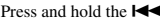
You can operate the PSP™ system without using the control panel by using the system buttons or the remote control.

	System button operation	Remote control operation
Play	Press the  button or start button.	Press the  button.
Pause	Press the start button.	Press the  button.
Display the UMD™VIDEO menu	Press the  button.*1	–
Stop	Press the  button.	–
Play the previous chapter	Press the L button.*1	Press the  button.*1
Play the next chapter	Press the R button.*1	Press the  button.*1
Fast Reverse	Press the left button.*2	Press and hold the  button.
Fast Forward	Press the right button.*2	Press and hold the  button.
Slow	Press the right button during pause.*2	During pause, press and hold the  button.

\*1 This operation cannot be performed during playback of video saved on a Memory Stick Duo™.

\*2 If you press and hold the button, the video will play in Fast Reverse/Fast Forward/Slow as long as the button is held down.

## Hint

Some buttons cannot be operated while the control panel is displayed on the screen. In this case, press the  button to clear the control panel.

# Video options menu

You can use the Video options menu to play a UMD™VIDEO or view information or delete videos saved on a Memory Stick Duo™.



## 1 Select the icon, and then press the button.

The options menu is displayed.



## 2 Select a menu item, and then press the button.

### Clearing the options menu

Press the  button or the  button.

### Options list

The options menu items available vary depending on the icon selected.

Play	Plays a UMD™VIDEO or a video saved on a Memory Stick Duo™
Play from Beginning	Plays a UMD™VIDEO from the beginning
Delete	Deletes a video saved on a Memory Stick Duo™
Information	Displays information about the selected icon

## Saving videos on a Memory Stick Duo™

The following two methods can be used to save a video on a Memory Stick Duo™.

### Images or video recorded with a device that is compatible with Memory Stick™

GB

Video

If you have a device that records video in a format\* that can be played on the PSP™ system, you can play the video simply by inserting the Memory Stick Duo™ from the compatible device into the PSP™ system.

- \* For information on video file types that can be played on the PSP™ system, see "Files that can be played" (▶▶ page 121).  
<http://www.memorystick.com/psp> for more information about compatible devices.

#### Hint

A Memory Stick Duo Adaptor (model number MSAC-M2: a Sony product sold separately) is required if your device can handle only a standard-size Memory Stick™.

## Transferring a video file from a PC to a Memory Stick Duo™

You can convert motion video that was taken or recorded on another device into a format that can be played on the PSP™ system and transfer it to a Memory Stick Duo™ using compatible software.\*

\* For full details, visit <http://www.memorystick.com/psp>

Files can be transferred using any of the following methods:

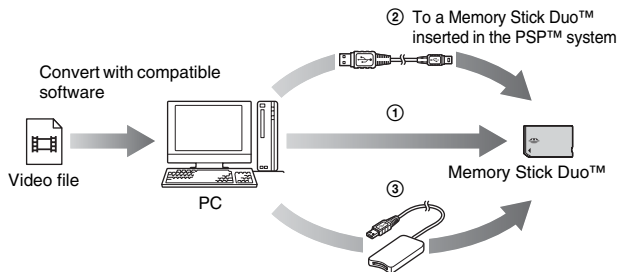

- ① Use a PC with a Memory Stick™ slot.\*
- ② Use a commercially available USB cable (\*\*▶ page 102).
- ③ Use a commercially available Memory Stick USB reader/writer.\*

\* If the device can handle only the standard-size Memory Stick™, you will need a Memory Stick Duo Adaptor (model number MSAC-M2: a Sony product sold separately).

### Hints

- See <http://www.memorystick.com/psp> for information on the formats that can be converted.
- The PSP™ system cannot play video data converted at bit rates higher than 768 kbps.
- Chinese language filenames must be changed to English or numerals. The PSP™ system cannot correctly display filenames written in Chinese.





## Listening to music

You can listen to UMD™MUSIC and music saved on a Memory Stick Duo™.

- 1 Select  from the home menu.
- 2 Insert a UMD™ or a Memory Stick Duo™ (→ pages 31, 32).  
An icon for the inserted media is displayed.





- 3 Select the icon, and then press the  button.  
Playback begins. When a list of groups or tracks is displayed, select the item you want to listen to and then press the  button.

### Hint

UMD™MUSIC containing video content (such as music videos) are played in the same way as UMD™VIDEO. For detailed instructions, see "Using the control panel" under "Video" (→ page 46).

### Icons displayed under Music

 UMD™	You can play UMD™MUSIC. If you select the icon, a thumbnail for the music is displayed.
 Memory Stick™	You can play music saved on a Memory Stick Duo™.

## Hints

- If the start button or the ►|| button on the remote control is pressed in step 3, the first track of the first group will begin playing.
- If the home button or select button is pressed during playback, the screen will return to the home menu. If the button is pressed again, the music playback screen will be displayed.
- You can adjust the tone or mute the sound using the sound button (•► page 34).
- For a list of file types that can be played on the PSP™ system, see "Files that can be played" (•► page 121).
- Title names and thumbnail images used in this manual are not of actual products.

## What is a Group?

A group is a collection of music data arranged in a certain order, such as by album or by artist. When Group Mode is turned on, the PSP™ system can play tracks in groups that were configured using a PC.

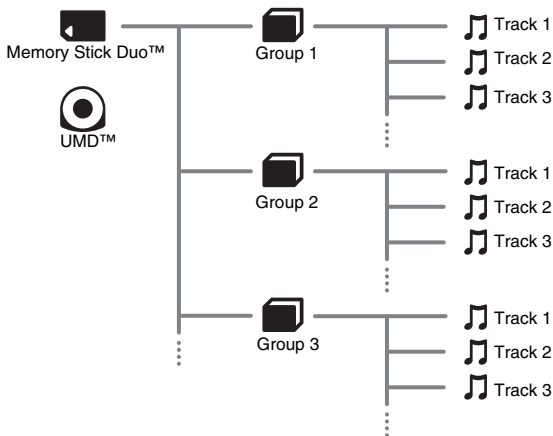

## Hints

- The PSP™ system cannot be used to create or edit a group.
- "Track" represents a song.
- UMD™MUSIC containing video content such as music videos do not support usage of the Group feature.

## Stopping playback

### 1 Press the (X) button during playback.

Playback stops.

## How to read the screen

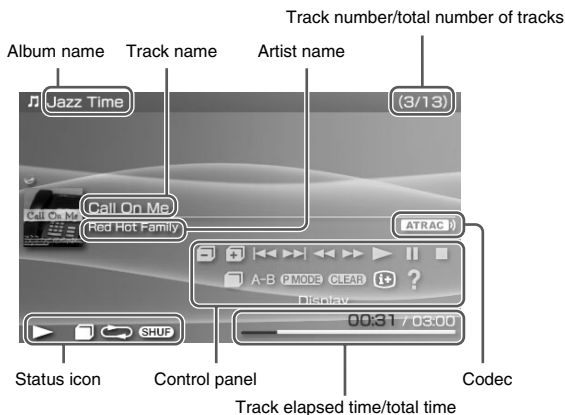

### Hints

- "Album name" and "Track number/total number of tracks" are shown on the screen only while (i+) (Display) is turned on.
- The icon or icons displayed in the "Status icon" field will vary depending on the playback mode selected.
- See "Playing with a selected codec" (\*\*▶ page 66) for details about codecs.

# Using the control panel

You can perform the following operations using the on-screen control panel.

## 1 Press the $\triangle$ button during playback.

The control panel is displayed.



## 2 Select an icon, and then press the $\odot$ button.

### Hint











UMD™MUSIC containing video content (such as music videos) are played in the same way as UMD™VIDEO. For detailed instructions, see "Using the control panel" under "Video" (▶▶ page 46).

## Clearing the control panel

Press the  $\triangle$  button or the  $\otimes$  button.

## List of operations

Icon	Description
Previous Group	Returns to the beginning of the previous group
Next Group	Skips to the beginning of the next group
Previous Track	Returns to the beginning of the track currently playing or to the beginning of the previous track

Icon		Description
	Next Track	Skips to the beginning of the next track
	Fast Reverse/ Fast Forward	Plays in fast reverse/fast forward*
	Play	Plays a track
	Pause	Pauses playback
	Stop	Stops playback
	Group Mode	Switches to Group Mode (**► page 61)
A-B	A-B Repeat	Specifies a part of a track, and then plays that part repeatedly (**► page 63)
	Play Mode	Switches to Play Mode (**► page 62)
	Clear	Clears Group Mode, Play Mode and A-B Repeat settings
	Display	Displays album name, track number and total number of tracks
	Help	Displays the functions that can be performed using the system buttons

\* If you press and hold the  button, the music will play in Fast Reverse/Fast Forward as long as the button is held down.



## Using Group Mode

Tracks can be played in groups. Playback stops after all tracks in the group have been played.

- 1** During playback, select  from the control panel, and then press the  button.

Group Mode is turned on, and then  is displayed on the screen.





## Clearing Group Mode

While Group Mode is on, select  from the control panel, and then press the  button.

### Using Play Modes (Repeat/Shuffle)



#### 1 During playback, select from the control panel, and then press the button.

Each time the  button is pressed, the system switches between the following functions:

Play Mode	Description
 1	Plays a track repeatedly
	Plays all tracks repeatedly
	Plays all tracks in a random order*
	Plays all tracks in a random order repeatedly
No icon	Clears Play Mode and plays through to the last track in normal order

\* If there is a group, tracks in the group are played in a random order. The order of the groups will not change.

#### Hint

Play Modes can also be cleared by selecting  from the control panel, and then pressing the  button.

## Playing part of a track repeatedly A-B

Specify and then play the part that you want to play repeatedly.

- 1 Select A-B from the control panel during playback, and then press the  button at the point where you want the repeated playback to begin.**

The starting point (point A) is set.

- 2 Press the  button at the point where you want the repeated playback to end.**

The ending point (point B) is set, and repeated playback of the specified section begins.

### Clearing A-B Repeat









Select **A-B** or **CLEAR** from the control panel, and then press the  button. The specified part is cleared, and normal playback resumes.

#### Hints

- The range for A-B Repeat can only be specified within a single track.
- If the ending point (point B) is not set, the end of the track will automatically become the ending point (point B).
- If A-B Repeat is set while in a Play Mode, the Play Mode will be cleared.

## Operating with PSP™ system buttons or the remote control

You can operate the PSP™ system without using the control panel by using the system buttons or the remote control.

	System button operation	Remote control operation
Play	Press the  button or start button.	Press the  button.
Pause	Press the start button.	Press the  button.
Stop	Press the  button.	–
Skip to the beginning of the current track or the previous track	Press the L button.	Press the  button. Or, press the  button as many times as the number of tracks you want to go back.
Skip to the beginning of the next track	Press the R button.	Press the  button.
Fast Reverse	Press the left button.*	Press and hold the  button.
Fast Forward	Press the right button.*	Press and hold the  button.

\* If you press and hold the button, the music will play in Fast Reverse/Fast Forward as long as the button is held down.

### Hints

- Some buttons cannot be operated while the control panel is displayed on the screen. In this case, press the  button to clear the control panel.
- UMD™MUSIC containing video content (such as music videos) are played in the same way as UMD™VIDEO. For detailed instructions, see "Using the control panel!" under "Video" (▶▶▶ page 46).



# Music options menu

You can use the Music options menu to view information about or delete music data saved on a Memory Stick Duo™.

## 1 Select an icon, and then press the $\triangle$ button.

The options menu is displayed.



## 2 Select a menu item, and then press the $\odot$ button.

### Clearing the options menu

Press the  $\triangle$  button or the  $\times$  button.

### Options list

The options menu items available vary depending on the icon selected.

Play	Plays UMD™MUSIC or music data saved on a Memory Stick Duo™
Play from Beginning	Plays UMD™MUSIC from the beginning
Select Codec	Sets a file format or bit rate for music playback (**▶ page 66)
Delete	Deletes music data saved on a Memory Stick Duo™
Information	Displays information about the selected icon

## Playing with a selected codec

With UMD™MUSIC that has multiple file formats and bit rates recorded, you can select from among these options for playback.

**1 Select a group you want to listen to, and then press the  button.**

**2 Select "Select Codec", and then press the  button.**

The types of file formats and bit rates are displayed. The items displayed in gray cannot be selected because they are of types that cannot be played on the system.

**3 Select the type of file format and bit rate that you want to listen to, and then press the  button.**

**4 Press the  button.**

The icons for groups are displayed.

**5 After selecting a group, select the track you want to listen to, and then press the  button.**

Playback begins.

### Hint

Items such as "ATRAC3plus™" represent the type of file format, while items such as "256 kbps" represent the bit rate. As a general rule, the higher the bit rate, the better the sound quality. See "Files that can be played" (▶▶ page 121) for details about file types.

# Transferring and saving music on a Memory Stick Duo™

You can use the PSP™ system to play music data obtained in the following ways:

- 1) Music imported from an audio CD.
- 2) Music purchased from a music download Web site.

See below for instructions regarding item 1).

See <http://www.memorystick.com/psp> for instructions regarding item 2).

GB

Music

## Importing tracks from an audio CD in ATRAC3plus™ format

A PC and software\* that supports ATRAC3plus™ are required to import tracks from an audio CD.

\* For full details, visit <http://www.memorystick.com/psp>

You can transfer the imported tracks to a Memory Stick Duo™ using either of the following methods:

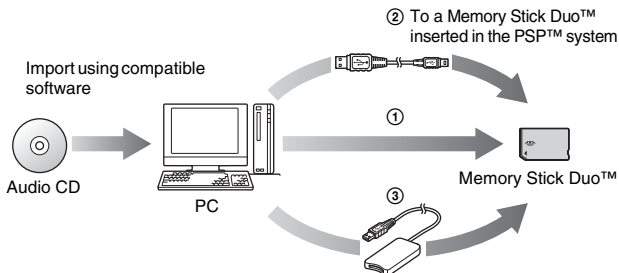

- ① Use a PC with a Memory Stick™ slot that supports MagicGate™.\*1
- ② Use a commercially available USB cable (▶▶ page 102)\*2
- ③ Use a commercially available Memory Stick USB reader/writer.\*1\*3

- \*1 If the slot on the device can handle only standard-size Memory Stick™ media, a Memory Stick Duo Adaptor (model number MSAC-M2: a Sony product sold separately) is required.
- \*2 A PC with Windows® XP and SonicStage™ version 3.1 or later installed is required.
- \*3 A device that supports MagicGate™ such as model number MSAC-US30 (a Sony product sold separately) is required.

## Hints

- For detailed information about importing tracks, see <http://www.memorystick.com/psp>
- With SonicStage™ software earlier than version 3.2, ATRAC3plus™ data cannot be saved to or played from Memory Stick PRO Duo™. In this case, use MagicGate-compatible Memory Stick Duo™ media of types other than Memory Stick PRO Duo™ (\*\*▶ page 119).
- The PSP™ system cannot play tracks that have a limitation of playback period or a limited count of playbacks.

## Importing tracks from an audio CD in MP3 format

A PC and compatible software are required to import tracks from an audio CD. You can save imported tracks on a Memory Stick Duo™ using any of the following methods:

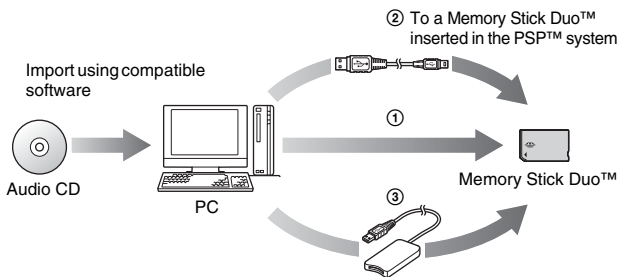

- ① Use a PC with a Memory Stick™ slot.\*
- ② Use a commercially available USB cable (\*\*▶ page 102).
- ③ Use a commercially available Memory Stick USB reader/writer.\*

\* If the slot on the device can handle only standard-size Memory Stick™ media, a Memory Stick Duo Adaptor (model number MSAC-M2: a Sony product sold separately) is required.

## Hint

The method of importing tracks varies depending on the software. For details, refer to the instructions supplied with the software.

## Where to save music data

Create a folder named "PSP" directly on the Memory Stick Duo™, and then create a folder named "MUSIC" in the "PSP" folder. Save music data in the "MUSIC" folder. The PSP™ system will not recognize data items saved anywhere other than in this folder.

\* The folder name does not need to be all capital letters.

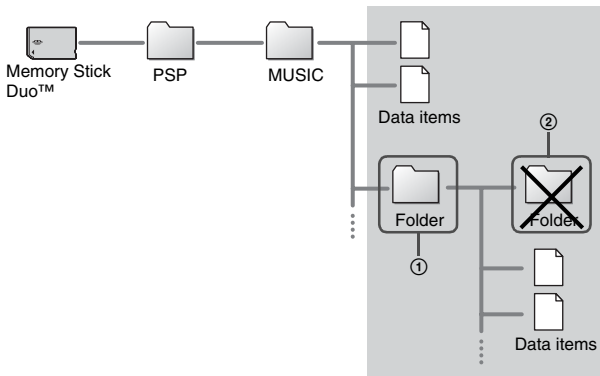



## Hints

- If a folder named "PSP" has already been created on the Memory Stick Duo™, create a "MUSIC" folder within it.
- You can create folders within the "MUSIC" folder (Figure ①). The system will treat it as a group.
- Folders created within sub-folders will not be recognized (Figure ②).
- If you want to specify the order of the tracks, create an m3u file specifying the order in the folder. The system will display the file as an  (m3u) icon, and treat it as a group.
- If a music file that is not of a supported file format is saved in the "MUSIC" folder, the system will not recognize it.
- Chinese language filenames must be changed to English or numerals. The PSP™ system cannot correctly display filenames written in Chinese.
- Music files in MP4(AAC) and WAV(Linear PCM) formats can be imported and played in the same way as MP3 format files.

## Viewing images

You can view images saved on a Memory Stick Duo™.

- 1 Select  from the home menu.
- 2 Insert a Memory Stick Duo™ (→ page 32).  
 is displayed.

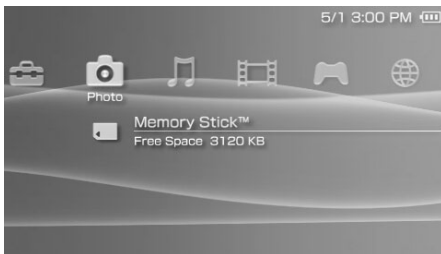

- 3 Press the  button while  is selected.

Icons for Digital Camera Images, folders and images saved on the Memory Stick Duo™ are displayed. Select the icon that you want to display, and then press the  button.

### Icons displayed under Photo

 Memory Stick™	You can view images saved on a Memory Stick Duo™.
---	---

#### Hints

- If you press the home button or select button while displaying an image, the screen will return to the home menu while continuing to display the image. If you press the button again, the screen will return to the image display screen.
- For a list of file types that can be played on the PSP™ system, see "Files that can be played" (→ page 121).

# Using the control panel

You can perform the following operations using the on-screen control panel.

## 1 Press the $\triangle$ button while displaying an image.

The control panel is displayed.

















## 2 Select an icon, and then press the $\odot$ button.

### Clearing the control panel



Press the  $\triangle$  button or the  $\otimes$  button.

### List of operations

Icon		Description
	Send	Sends an image (**▶ page 77)
	Set as Wallpaper	Sets the currently displayed image as wallpaper (**▶ page 74)
	View Mode	Changes the size of the image displayed (**▶ page 73)
	Display	Displays information about the image (**▶ page 72)

Icon		Description
	Help	Displays the functions that can be performed using the PSP™ system buttons
	Clear Zoom	Returns an image that has been zoomed in or out to its original size
	Zoom Out	Zooms out from the image
	Zoom In	Zooms in on the image
	Rotate Left	Rotates the image 90-degrees counterclockwise
	Rotate Right	Rotates the image 90-degrees clockwise
	Up/Down/Left/Right	Moves the image to display any obscured parts in cases such as when the image has been zoomed on, or when View Mode is set to Zoom
	Previous	Displays the previous image
	Next	Displays the next image
	Slideshow	Automatically displays each image in order (▶▶▶ page 78)

## Displaying image information

- 1 While displaying an image, select  from the control panel, and then press the  button.  
The image status is displayed.



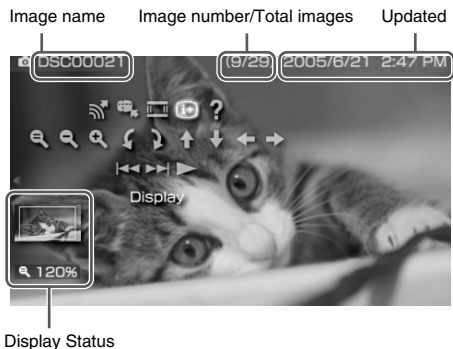

## Clearing the display

Select **(i+)** from the control panel, and then press the **(O)** button.

## Adjusting image size **(||)**

You can change the size of the image displayed on the screen.

- 1 While displaying the image, select **(||)** from the control panel, and then press the **(O)** button.

Each time you press the button, the option switches as follows:



Normal	Displays the image to fit the screen size without changing proportions
Zoom	Displays the image at the full screen size without changing proportions. Portions of the image at the top and bottom or left and right are cut off.

### Hint

Depending on the image being displayed, the View Mode may not change.

## Setting an image as wallpaper

You can set the currently displayed image as wallpaper.

**1 With an image displayed, select  from the control panel, and then press the .**

**2 Select "Yes", and then press the .**

"Save completed" is displayed and the setting is complete.

### Hints

- You can only save one image as wallpaper on the PSP™ system. If you have wallpaper set and perform this setting, the existing image will be overwritten.
- If you have manipulated the image such as by zooming or rotating, the image will be saved as wallpaper exactly as it appears on the screen.
- If you do not want to show wallpaper, you can change the setting in "Wallpaper" (▶▶ page 94) under "Theme Settings".

## Operating with PSP™ system buttons or the remote control

You can operate the PSP™ system without using the control panel by using the system buttons or the remote control.

	System button operation	Remote control operation
Play a slideshow	Press the start button.	Press the ►   button.
Cancel zoom in/out	Press the ⊙ button when the image has been zoomed in or out.	–
Back	Press the ⊗ button.	–
Display the previous image	Press the L button.	Press the ◀◀ button.
Display the next image	Press the R button.	Press the ▶▶ button.
Zoom in	Move the analog stick up while holding down the ⊕ button.	–
Zoom out	Move the analog stick down while holding down the ⊕ button.	–
Rotate (Left)	Press the L button while holding down the ⊕ button.	–
Rotate (Right)	Press the R button while holding down the ⊕ button.	–
Move*	Move the analog stick.	–

\* Obscured parts of the image can be displayed in cases such as when you have zoomed in on the image, or when the View Mode is set to Zoom.

### Hint

Some buttons cannot be operated while the control panel is displayed on the screen. In this case, press the △ button to clear the control panel.

# Photo options menu

When the Photo options menu is displayed, you can view information about or delete images saved on a Memory Stick Duo™.

## 1 Select an icon, and then press the $\Delta$ button.

The options menu is displayed.

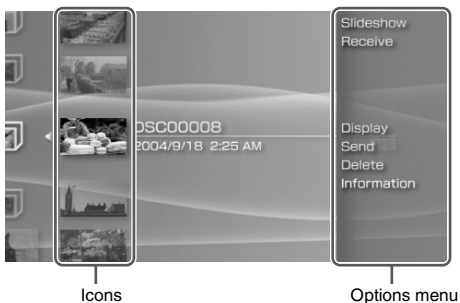

## 2 Select a menu item, and then press the $\odot$ button.

### Clearing the options menu

Press the  $\Delta$  button or the  $\times$  button.

### Options list

The options menu items available vary depending on the icon selected.

Slideshow	Automatically displays each image in order (**► page 78)
Receive	Receives an image (**► page 77)
Display	Displays images
Send	Sends an image (**► page 77)
Delete	Deletes folders or images
Information	Displays information about the selected icon

## Sending and receiving images

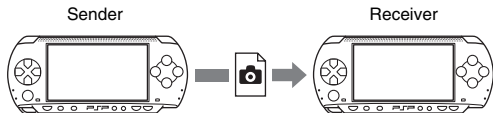

You can transfer images with another PSP™ system using ad hoc mode (►► page 104). The steps for the sender and the receiver are different.





### 1 Set up for ad hoc mode. (both sender and receiver)

- 1 Turn on the WLAN switch on the left side of the PSP™ system (►► page 21).

### 2 Prepare to receive the image. (receiver)



- 1 Under , select the icon for the location where you want to save the image, and then press the  button.
- 2 Select "Receive", and then press the  button.  
The system is now ready to receive an image.

### 3 Send the image. (sender)

- 1 Select the image you want to send, and then press the  button.
- 2 Select "Send", and then press the  button.  
The nicknames for PSP™ systems ready to receive an image are displayed.
- 3 Select the system to send to, and then press the  button.  
The system starts to send the image.

### 4 Save the image that you received. (receiver)

When the transfer is completed, the image that was received is displayed on the screen.

- 1 With the image displayed, press the  button.  
A confirmation message is displayed.
- 2 Select "Yes", and then press the  button.

#### Hints

- The location where an image is saved depends on your selection in step 2-1. Note that you cannot save images in the Digital Camera Images folder.
- You can also transfer images from the on-screen control panel (►► page 71).

# Playing slideshows

You can set the available images to be displayed in order.

## 1 Select the icon for a folder or media containing images, and then press the start button.

The slideshow begins. The content displayed varies depending on the icon selected.

Icon	Description
Memory Stick™	All images saved on a Memory Stick Duo™ are displayed in order.
Digital Camera Images	All images in the Digital Camera Images folder are displayed in order.
Folder	All images in the selected folder are displayed in order.
Images	Images are displayed in order, starting from the selected image.

## Stopping a slideshow

Press the (X) button.

### Hints

- The display speed of the images can be adjusted. See "Photo Settings" (\*\*▶ page 90) for details.
- The slideshow can also be started in the following ways:
  - From the options menu (\*\*▶ page 76).
  - From the image control panel (\*\*▶ page 71).

## Using the control panel

## 1 Press the (Δ) button during the slideshow.

The control panel is displayed.

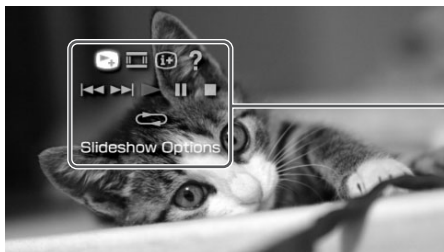

Control panel

**2** Select an icon, and then press the button.

## Clearing the control panel

Press the button or the button.

## List of Operations

Icon		Description
	Slideshow Options	Switches the information displayed on the screen (**▶ page 80)
	View Mode	Changes the size of the image displayed on the screen
	Display	Displays image information
	Help	Displays the functions that can be performed using the PSP™ system buttons
	Previous	Displays the previous image
	Next	Displays the next image
	Play	Starts the slideshow
	Pause	Pauses the slideshow
	Stop	Stops the slideshow

Icon	Description
 Repeat	Plays the slideshow repeatedly

## Displaying slideshow options





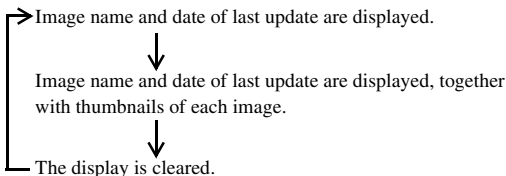

- 1** During a slideshow, select  from the control panel, and then press the  button.

Each time you press the  button, the option switches as follows:



## Operating with PSP™ system buttons or the remote control

You can operate the PSP™ system without using the control panel by using the system buttons or remote control.

	System button operation	Remote control operation
Playing a slideshow	Press the start button.	Press the  button.
Pausing a slideshow	Press the start button.	Press the  button.
Stopping a slideshow	Press the  button.	-
Displaying the previous image	Press the L button.	Press the  button.
Displaying the next image	Press the R button.	Press the  button.
Displaying slideshow options	Press the  button.	-



## Hint

Some buttons cannot be operated while the control panel is displayed on the screen. In this case, press the  button to clear the control panel.

## Saving images on a Memory Stick Duo™

The following two methods can be used to save images on a Memory Stick Duo™.

### Taking photos using a digital still camera

When using a digital still camera that is compatible with the Memory Stick Duo™, photos can be displayed by inserting the Memory Stick Duo™ from the camera directly into the PSP™ system. Photos on the Memory Stick Duo™ will be displayed in the system's "Digital Camera Images" folder.

#### Hint

You can use Memory Stick Duo™ media with a digital still camera that can handle only the standard-size Memory Stick™ by using a Memory Stick Duo Adaptor (model number MSAC-M2: a Sony product sold separately).

### Saving image data items from a PC to a Memory Stick Duo™

You can save images using any of the following methods:

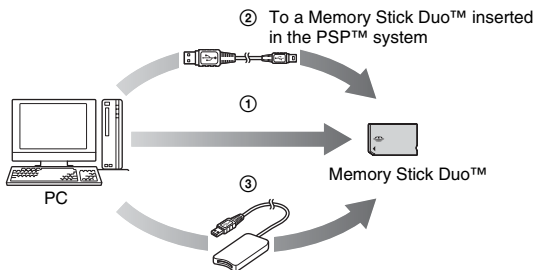

- ① Using a PC with a Memory Stick™ slot.\*
- ② Using a commercially available USB cable (➡ page 102).
- ③ Using a commercially available Memory Stick USB reader/writer.\*

\* A Memory Stick Duo Adaptor (model number MSAC-M2: a Sony product sold separately) is required if the slot on the device you are using is able to handle only the standard-size Memory Stick™.

## Where to save image data

Create a folder named "PSP" directly on the Memory Stick Duo™, and then create a folder named "PHOTO"\* in the "PSP" folder. Save image data in the "PHOTO" folder. The PSP™ system will not recognize data items saved anywhere other than in this folder.

\* The folder name does not need to be all capital letters.

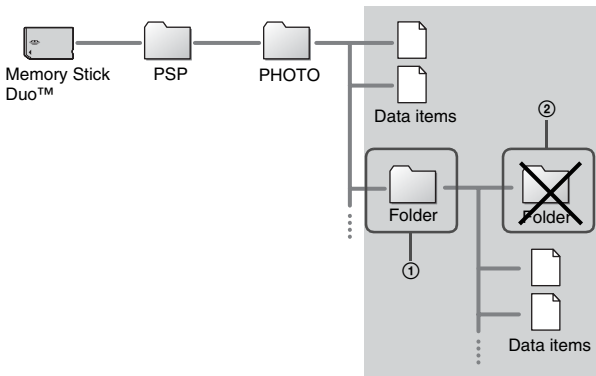

### Hints

- If a folder named "PSP" has already been created on the Memory Stick Duo™, create a "PHOTO" folder within it.
- You can create folders within the "PHOTO" folder (Figure ①).
- Folders created within sub-folders will not be recognized (Figure ②).
- It may not be possible to display some images, depending on the size of the image data.
- Images edited using a PC may not be viewable on the PSP™ system.
- Chinese language filenames must be changed to English or numerals. The PSP™ system cannot correctly display filenames written in Chinese.

# Connecting to the Internet

You can connect to the Internet to view Web pages using the Internet browser. Note that you must be in an Internet-accessible location to connect to the Internet.

### 1 Check that you have completed network settings.

To connect to the Internet, you must first enter settings and save a connection for infrastructure mode (→▶ page 104).

### 2 Select under from the home menu, and then press the button.

The Internet browser starts, and the menu is displayed.



### 3 Using the up button, select the address bar, and then press the button.

The on-screen keyboard is displayed.



### 4 Enter the address for the Web page using the on-screen keyboard ([▶▶ page 114](#)).

After you have entered the address, the PSP™ system will connect to the Internet. While the page is loading, the busy icon is displayed in the lower right corner of the screen. When a connection is successfully established, the Web page will be displayed.

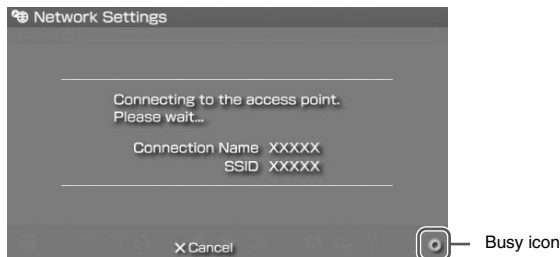

## 5 Once the Web page is displayed, press the button to hide the menu.

By pressing the  button, you can switch between displaying and hiding the menu. From the menu bar, you can access various features and settings such as "Back" and "Close Page".

### Hints

- If you try to open a Web page using the Internet browser when a connection to the Internet has not been established, the system will automatically try to connect to the Internet.
- Usually, the most recently used connection will be automatically selected when connecting to the Internet.
- The Internet Browser does not officially support Chinese language display. For the latest information, visit  
<http://www.sceh.com.hk> (Hong Kong, Southeast Asia)  
<http://www.sceh.com.tw> (Taiwan)

For detailed instructions on how to use the Internet browser, refer to the Web page for the Internet browser usage manual.  
<http://www.playstation.com/manual/psp/>

## Closing the Internet browser

### 1 With the Internet browser displayed, press the button.

The Internet browser closes.

Users are responsible for all actions taken in browsing the Web site as well as playing and downloading files from the Internet. Except to the extent prohibited by applicable laws, Sony Computer Entertainment Inc. and/or any of its affiliates shall not be liable for any loss or damage to your Internet Browser or PSP™ (PlayStation®Portable) system, nor for any deletion or damage to your saved data on Memory Stick DUO™, arising out of your act of browsing websites and of playing, downloading, and running files on the Internet.

# Settings for the PSP™ system

You can adjust the settings for the PSP™ system, as well as settings for features, such as video, photo and network.

## 1 Select from the home menu.



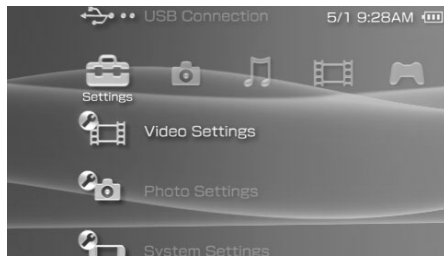







Icons for various settings are displayed.



## 2 Select an icon, and then press the button.

A setting screen for the selected icon is displayed. For details, see the instructions for each setting (▶▶ pages 88-113).

## Icons displayed under Settings

	Network Update	Provides access to updates for the system software (**▶ page 111)
	USB Connection	Allows for connection to a PC using a commercially available USB cable (**▶ page 102)
	Video Settings	Includes settings for UMD™VIDEO Menu Language, Audio Language and Subtitle Language (**▶ page 89)
	Photo Settings	Includes settings for adjusting the slideshow speed (**▶ page 90)
	System Settings	Includes settings for the System Language and Nickname, and provides an option to format Memory Stick Duo™ media (**▶ page 91)
	Theme Settings	Allows the user to change the background color and display an image as wallpaper (**▶ page 94)
	Date & Time Settings	Allows the user to set the date and time, as well as adjust for daylight saving time (**▶ page 95)
	Power Save Settings	Includes settings to automatically turn off the backlight and put the system in sleep mode (**▶ page 96)
	Sound Settings	Provides access to settings for AVLS (Automatic Volume Limiter System) and Key Tone (**▶ page 98)
	Security Settings	Allows the user to change the password and adjust the level setting for the parental control feature (**▶ page 99)
	Network Settings	Provides access to settings for connecting to a wireless local area network (WLAN) (**▶ page 104)



## Video Settings

You can set the UMD™VIDEO language or boost UMD™VIDEO volume.

---

---

### Notice

Depending on the UMD™VIDEO, playback conditions may be set in advance by the software developer. In such cases, certain options may not be available, even if you follow the instructions in this manual.

---

Menu Language	Select a language for the UMD™VIDEO menu.
Audio Language	Select a language for the audio.
Subtitle Language	Select a language for subtitles.
UMD™Video Volume	Adjust the volume when UMD™VIDEO output level is low. The volume increases in the following order: "Normal", "+1" and "+2".

### Hint

The settings at the time of purchase are as follows:

- "Menu Language" and "Subtitle Language" are set to "English" (for PSP-1006 K) or "Chinese" (for PSP-1007 K).
- "Audio Language" is set to "Original Language".
- "UMD™Video Volume" is set to "Normal".

## Photo Settings

You can set the Slideshow Speed.

Fast	Displays images at a faster rate
<u>Normal</u>	Displays images at normal speed
Slow	Displays images at a slower rate

The default setting for the menu item is underlined.

## System Settings

You can adjust the settings for and display information about the PSP™ system, or format a Memory Stick Duo™.

### Nickname

The nickname you selected in the initial setup can be changed. Use the on-screen keyboard to enter a new nickname. For details on entering text, see "How to use the keyboard" (→▶ page 114).

### System Language

Sets the language for system menus, such as the home menu.

Deutsch	Displays messages in German
<u>English</u>	Displays messages in English
Español	Displays messages in Spanish
Français	Displays messages in French
Italiano	Displays messages in Italian
Nederlands	Displays messages in Dutch
Português	Displays messages in Portuguese
Русский	Displays messages in Russian
日本語	Displays messages in Japanese
한국어	Displays messages in Korean

The default setting for the menu item is underlined.

## Character Set

You can set the character code to be applied to music and other types of files. It usually is not necessary to adjust this setting.

For File Names	Sets the character code to be used in music and other file names
For Text in Files	Sets the character code for text in m3u and other types of files

### Hint

The default setting is "Multilingual Latin 1 (850)".

## Battery Information

You can display the following information about the system battery:

Charge Level	Displays the battery charge level as a percentage
Hours Left*	Displays the remaining hours of battery duration (except when charging)
Power Source	Displays the current source of power: "External" or "Battery"
Battery Status	Displays the status of the battery: "In Use", "Charging" or "Charge Complete"

\* The number of hours as calculated by the system is shown as an estimate.

### Hint

There may be a slight difference between the display information and actual battery performance. This is due to variations in actual usage conditions and environmental factors (such as temperature).

## Format Memory Stick™

You can format Memory Stick Duo™ media using the system. Follow the on-screen instructions to perform this operation.

---

---

## Notice

When you format, all software and data stored on the Memory Stick Duo™ will be deleted and cannot be recovered. Be careful not to accidentally erase important data.

---

## Restore Default Settings

You can restore settings to the values as set at the time of purchase. Follow the on-screen instructions to perform this operation.

---

## Notices

- When the default settings are restored, the current settings will be lost and cannot be recovered.
  - After an update has been performed, this feature cannot be used to go back to a previous version of the system software.
- 

## System Information

You can display information about the PSP™ system.

MAC Address	Displays the MAC address
System Software	Displays the version of the system software
Nickname	Displays the nickname

## About PSP™ (PlayStation®Portable)

Displays trademark and copyright information related to software used by the PSP™ system.

## Theme Settings

You can change the theme for the PSP™ system screen or display an image as wallpaper.

### Theme

You can change the background color of the screen. Use the directional buttons to select a background color, and then press the  button to complete the setting.

<u>Original</u>	Changes automatically to a preset color each month
Color swatches	Sets to the selected color

The default setting for the menu item is underlined.

### Wallpaper

You can select between displaying and not displaying wallpaper.

<u>Do Not Use</u>	Sets to not display wallpaper
Use	Displays the image set as wallpaper under  (Photo) (▶▶ page 74)

The default setting for the menu item is underlined.

## Date & Time Settings

You can set the date and time, time zone and daylight saving time for the PSP™ system. Set each item using the directional buttons and enter the setting by pressing the  button.

Date and Time	Sets the year, month, day, hour, minute and second (and AM/PM setting if using a 12-hour time format)
Date Format	Sets the order of year, month and day displayed on the screen
Time Format	Sets to use the 12-hour or 24-hour display format
Time Zone	Sets the appropriate time zone
Daylight Saving	Selects either "Standard" or "Daylight Saving" (Standard is the default)

### Hints

- When the time zone is changed, the date and time settings are automatically adjusted based on the time difference between the old and new time zones.
- If "Theme" ( page 94) is set to "Original", when you change the month setting under "Date & Time Settings", the background color will change automatically.

## Power Save Settings

You can conserve the power of the PSP™ system by setting the system to automatically switch off the backlight or go into sleep mode.

### Backlight Auto-Off

When the system remains idle for a certain period of time, it saves power by automatically turning off the backlight on the LCD screen. When the backlight is turned off, the screen goes blank.

Off	The backlight does not turn off automatically.
2 minutes	Turns the screen darker after one minute and turns off the backlight after another minute
<u>5 minutes</u>	Turns the screen darker after one minute and turns off the backlight after four more minutes
10 minutes	Turns the screen darker after one minute and turns off the backlight after nine more minutes

The default setting for the menu item is underlined.

### Turning on the backlight

When the backlight is turned off automatically, press any of the system buttons to turn it back on.

#### Hint

The Backlight Auto-Off feature may not work during the following operations:

- During video playback
- While playing a slideshow



## Auto Sleep

You can set the system to conserve power by automatically entering sleep mode when it remains idle for a certain period of time. For details on clearing sleep mode, see "Clearing sleep mode" (➡ page 30).

Off	The system does not automatically go into sleep mode.
5 minutes	Enters sleep mode after five minutes
<u>10 minutes</u>	Enters sleep mode after ten minutes
15 minutes	Enters sleep mode after fifteen minutes

The default setting for the menu item is underlined.

### Hint

The Auto Sleep feature may not work during the following operations:

- When connected using the AC adaptor
- While playing a game
- During video playback
- During music playback
- While playing a slideshow

## WLAN Power Save

You can switch the power mode of the wireless networking feature. If you select "On", the system will communicate with reduced power consumption.

<u>Off</u>	Communications set to maximum power
On	Communications set to power-save mode

The default setting for the menu item is underlined.

---

### Notice

If you set to "On", the system may not be able to communicate correctly in certain environments. In such cases, change the setting to "Off".

---

## Sound Settings

You can turn off the key tone and limit the volume level.

### AVLS (Automatic Volume Limiter System)

You can limit the maximum volume. This can help prevent sound escaping from the headphones, as well as the possible danger resulting from being unable to hear what is going on around you when wearing headphones.

<u>Off</u>	Does not set a limit; allows for the volume to be adjusted manually
On	Sets a limit on the volume

The default setting for the menu item is underlined.

### Key Tone

You can turn off the key tone (the confirmation sound made when you press a button).

Off	Does not make a confirmation sound
<u>On</u>	Makes a confirmation sound

The default setting for the menu item is underlined.







You can adjust settings related to PSP™ system security features.

## Change Password

Changes the 4-digit password. The password is required for the following operations:

- To change the "Parental Control Level" or "Internet Browser Start Control" settings
- To play a UMD™ that is restricted by the system's Parental Control Level setting
- To start the browser when "Internet Browser Start Control" is set to "On"
- To change the password

## Change Password

- 1** Select  (Security Settings) under  from the home menu, and then press the  button.
- 2** Select "Change Password", and then press the  button.  
The password entry screen is displayed.
- 3** Using the directional buttons, enter the current 4-digit password, and then press the  button.  
When changing the password for the first time after purchase, you must enter "0000".
- 4** Using the directional buttons, enter a new 4-digit password, and then press the  button.
- 5** Select "Yes", and then press the  button.  
The password is changed.

### Hint

Make a record of your password for future reference.

## Parental Control Level

Some UMD™ software have a preset parental control level based on the content. You can set the parental control level on the system to restrict the playback of a UMD™ with a level that is higher than that set on the system.

### Parental Control Level

The parental control level of the system can be either turned off or set to one of 11 different levels.

Off	Turns off parental control
11-1	Sets the level of content to be restricted. A setting of "1" is the most restrictive; "11" is the least restrictive.

The default setting for the menu item is "9".

The combination of the parental control levels of both the PSP™ system and the UMD™ determine whether a UMD™ can be viewed or not. The combination of the two levels is displayed in the table on page 101.

Example: If the parental control level of the system is set to "9", a UMD™ with a level from "1" to "9" can be played on the system.

		UMD™ parental control level											
		1	2	3	4	5	6	7	8	9	10	11	
System parental control level	11	■	■	■	■	■	■	■	■	■	■	■	■
	10	■	■	■	■	■	■	■	■	■	■	■	□
	9	■	■	■	■	■	■	■	■	■	■	■	□
	8	■	■	■	■	■	■	■	■	■	■	■	□
	7	■	■	■	■	■	■	■	■	■	■	■	□
	6	■	■	■	■	■	■	■	■	■	■	■	□
	5	■	■	■	■	■	■	■	■	■	■	■	□
	4	■	■	■	■	■	■	■	■	■	■	■	□
	3	■	■	■	■	■	■	■	■	■	■	■	□
	2	■	■	■	■	■	■	■	■	■	■	■	□
	1	■	■	■	■	■	■	■	■	■	■	■	□

■ :The UMD™ can be viewed.

□ :The UMD™ cannot be viewed.

## Parental control levels on games

For the latest information about ratings, call the PSP™ service line at the number listed on your warranty card for assistance.

### Hints

- The parental control level of a UMD™ can be checked under "Information" in the UMD™ options menu. For a UMD™ that does not include a parental control level, the "Parental Control Level" item under "Information" will display "-".
- A UMD™ that has been restricted by the parental control feature is displayed as  (Restricted Content).

## Internet Browser Start Control

You can restrict the ability to start the Internet browser.

<u>Off</u>	Allows the Internet browser to be started
On	Displays the password entry screen before starting the Internet browser

The default setting for the menu item is underlined.

## USB Connection

You can transfer files from a PC to a Memory Stick Duo™ inserted in the PSP™ system using a commercially available USB cable. Note however that files that can be played are limited to file formats supported by the system.

### USB cables that can be used with the PSP™ system

A USB cable compatible with the Mini-B (5-pin) type connector is required to connect to the system.

#### Hint

You can connect to a PC with an operating system that supports the USB mass storage class, such as Windows® XP or Mac OS X.

### Connecting the system and a PC using a USB cable

You can connect a USB cable to the system and the PC without turning off the power.

#### 1 Connect a USB cable to the system and a PC.

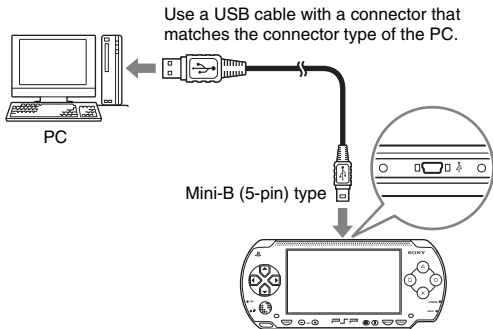

## 2 Select (USB Connection) under from the home menu, and then press the button.

The Memory Stick Duo™ inserted in the system is detected by the PC.

---

---

### Notice

Do not format a Memory Stick Duo™ on a PC, as it may no longer be recognized by the PSP™ system.

---

## Network Settings

You can adjust the network settings to allow connection to a wireless local area network (WLAN). There are two WLAN modes.

### **Warning**

Turn off the WLAN switch when in crowded places, such as in a crowded train. If a person nearby is using a pacemaker, it is possible that the radio waves could affect the pacemaker.

## Ad Hoc Mode

In this mode, you can communicate directly with other PSP™ systems. To establish a connection in ad hoc mode, both PSP™ systems must either be set to "Automatic" or to the same channel. For details, refer to the instructions supplied with the ad hoc mode-compatible software.

Communication with other PSP™ systems over a WLAN



<u>Automatic</u>	Automatically switches to the optimum channel for communication
Ch 1, Ch 6 or Ch 11	Communicates using the specified channel

The default setting for the menu item is underlined.

## Infrastructure mode

In this mode, you can connect the PSP™ system to a network using an access point.

This is used to connect to the Internet (•▶ page 84) or for features such as Network Update (•▶ page 111).



## Required items

The following items are generally required to set up the system to connect to a network and perform a network update.

- Subscription to an Internet service provider
- A network device, such as a DSL or cable modem
- A WLAN access point or a wireless broadband router
- A PC
- Settings for the access point (SSID, WEP key, WPA key, etc. as specified when the access point was configured)

### Hints

- An access point is a device used to connect to a wireless network.
- SSID, WEP and WPA keys are types of wireless network information. They may be required when connecting to an access point or a router. This information is generally set in the access point or router using a PC. For details, refer to the instructions supplied with the access point or router.



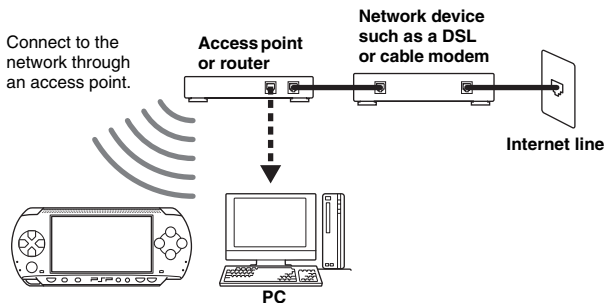

## Example of a network configuration



Network equipment connections and setup methods vary depending on the equipment used.



## Creating a new network connection

You can adjust network settings to connect to an access point and save the network connection data on the system. Up to ten connections can be saved.

- 1** Select  (Network Settings) under  from the home menu, and then press the  button.
- 2** Select "Infrastructure Mode", and then press the  button.
- 3** Select "New Connection", and then press the  button.
- 4** Enter a name for the network connection.

When you press the  button, an on-screen keyboard ( page 114) is displayed, allowing you to enter characters for the name. You can choose any name you like for the network connection.



When you have finished entering your settings, press the right button to go to the next screen.

- 5** Set the SSID for the access point.

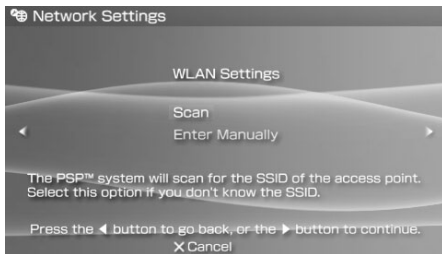

This screen is used to enter information for the settings listed on the next page. Refer to the instructions supplied with the access point or router for setting details.

Scan	Searches for nearby access points and displays the SSIDs
Enter Manually	Allows the user to enter the SSID using the keyboard. Select this option if you know the SSID of the access point.

When the settings have been completed, press the right button to go to the next screen.

## 6 Enter security information for the access point.

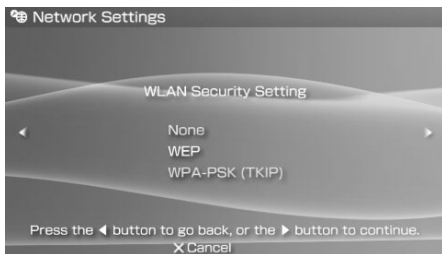

You can set the options listed below. If you have questions about which items are needed for your network, contact the network administrator.

None	Does not set security information.
WEP	Sets security information. Press the right button to move to the screen for entering WEP or WPA keys.*
WPA-PSK (TKIP)	

\* The WEP or WPA key fields will display eight asterisks no matter how many characters you enter as the key

When the settings have been completed, press the right button to go to the next screen.

## 7 Select the address setting method.

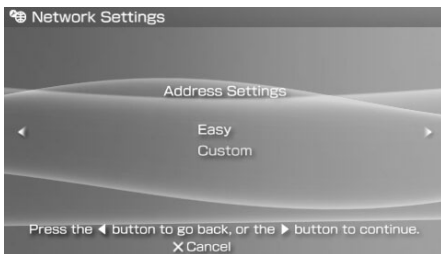

This screen is used to select the settings listed below. Most home networks will allow you to use the settings shown in the "Easy" setup (this is the recommended setup).

Easy	The following information is automatically set. - IP address settings: Automatic - DNS settings: Automatic - Proxy server: Do Not Use - Internet Browser: Do Not Start
Custom	You can manually enter detailed setting information, such as is used with a static IP network. For details, refer to the instructions supplied with the network device or the information provided by your Internet service provider.

When you have finished selecting your settings, press the right button to go to the next screen.

## 8 Check the settings.

This screen displays the setting details. Press the left button to return to the previous screens to correct any of the settings, if necessary.

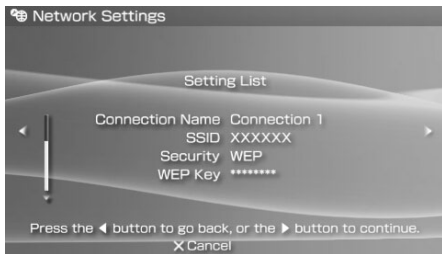

When you have finished selecting your settings, press the right button to go to the next screen.

## 9 Save the connection.

Press the  button to save the connection on your system.

## 10 Test the connection.

Before testing the connection, check that the PSP™ system's WLAN switch is turned on.

Select "Test Connection", and then press the  button. The system will connect to the selected access point.

## 11 Confirm the connection test results.

If the connection is successful, information about the network connection is displayed. Press the  button to end the connection test.

### Hints

- The system will also perform an Internet connection test after connecting to an access point. The results of the Internet connection test will be shown in the connection results screen.
- If the connection test fails, follow the on-screen instructions to check the settings. Network settings for the connection can be changed from the options menu (▶▶ page 110). For additional information, refer to the instructions supplied with the network device and by your Internet service provider.
- If the IP address and DNS information will be obtained by a DHCP server, select "Custom" in step 7. Each option will be set to "Automatic".





- If you want the browser to start automatically when a connection to an access point is established, in step 7 select "Custom", then set the "Internet Browser" option to "Start". Use this setting in cases such as when playing an online game at a hotspot that requires a browser to log in.
- Depending on the access point settings, you may need to enter the system's MAC address to connect to the network. The system's MAC address can be checked under "System Information" (▶▶ page 93).

## About DNAS

Sony Computer Entertainment Inc. uses DNAS (Dynamic Network Authentication System), a proprietary authentication system, to help protect copyright and security in connecting the PSP™ system to a network. DNAS may retrieve information about a user's hardware and software for authentication, copy protection, account blocking, system, rules, or game management and other purposes. The information collected does not identify the user personally. The unauthorized transfer, exhibition, export, import or transmission of programs and devices circumventing its authentication scheme may be prohibited by law.

## Network settings options menu

When the options menu is displayed in infrastructure mode, network connections saved on the system can be edited or deleted.

- 1 Select  (Network Settings) under  from the home menu, and then press the  button.**
- 2 Select "Infrastructure Mode", and then press the  button.**
- 3 Select a connection, and then press the  button.**

The items listed below are displayed. Select the operation that you want to perform, and then press the  button.

Edit	Changes the settings of a network connection saved on the system*
Test Connection	Tests the connection to an access point
Delete	Deletes a network connection
Information	Displays information about a network connection

\* For detailed instructions, see "Creating a new network connection" (▶▶ page 105).

## Network Update

You can update the system software for the PSP™ system using the Network Update feature.

For details on updates, see "PSP Updates" (▶▶ page 117).

For the latest information about updates, visit

<http://www.sceh.com.hk> (Hong Kong, Southeast Asia)

<http://www.sceh.com.tw> (Taiwan)

GB

Settings

### Network update process

#### Connect to the network

Connect using a wireless LAN access point.

Turn on the WLAN switch on the left side of the PSP™ system.



#### Download (receive data)

Download update data from the network. The update data is saved on the Memory Stick Duo™ inserted in the system.



#### Update (software update)

Update the system software using the data saved on a Memory Stick Duo™.

---

### Notice

During a download/update:

- do not remove the Memory Stick Duo™
- do not turn off the system
- do not disconnect the AC adaptor

The system software may be damaged if the update is interrupted.

---



## Starting a network update

You can connect to a network using an access point to download update data. Before starting, check that the battery is charged.

**1 Insert a Memory Stick Duo™ in the PSP™ system.**

**2 Connect the AC adaptor to the system.**

If the AC adaptor is not connected, you cannot start the update even if you have downloaded the update data.

**3 Select  (Network Update) under  from the home menu, and then press the  button.**

**4 Select a connection, and then press the  button.**

The system will connect to the network using an access point.

If you have not created and saved a connection, select "New Connection", and then press the  button to display the settings screen (➡ page 105).

**5 Download the update data.**



When connected to the network, the system automatically scans for the latest update data. Follow the on-screen instructions to download the update data and to start the update.

### Hint

Once the update has been completed, you can delete the update data from the Memory Stick Duo™.

## Network update options menu

When the options menu is displayed, connections saved on the system can be edited or deleted.

**1 Select  (Network Update) under  from the home menu, and then press the  button.**

**2 Select the connection, and then press the  button.**

The following items appear. Select the operation you wish to perform, and then press the  button.



Connect	Connects to an access point
Edit	Changes the settings of a network connection saved on the system*
Delete	Deletes a network connection
Information	Displays information about a network connection

\* For detailed instructions, see "Creating a new network connection" (\*\*► page 105).





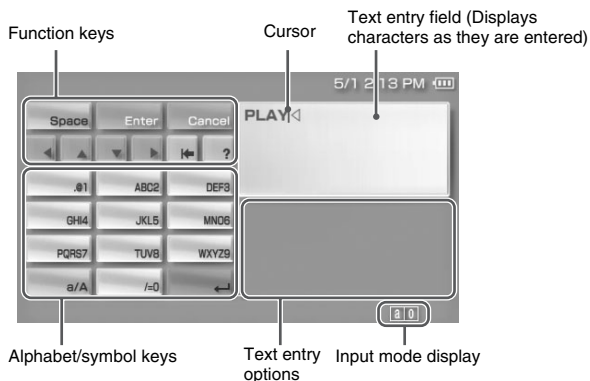

# How to use the keyboard



You can use the on-screen keyboard for text entry such as when entering a nickname for the PSP™ system or entering network setting information.

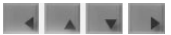

## Control panel item list





The keys that are displayed vary depending on the state of text entry.

Keyboard keys	Function
	Enters a space
	When entering text in the Internet browser address field, previously entered addresses are displayed. Addresses are displayed only when input mode is set to Web address shortcuts
	Confirms characters that have been typed but not entered, and exits the keyboard
	Cancels characters that have been typed but not entered, and exits the keyboard
	Moves the cursor
	Deletes the character to the left of the cursor

Keyboard keys	Function
	Displays a diagram showing the system buttons and their usage
	Switches between upper and lower case
	Enters a line break

## Switching input mode

The number of input modes available varies depending on the language selected. Every time you press the select button, the input mode switches among the options in the diagram below:

Input mode display	Input mode	Examples of characters you can enter
	Letters and numbers	a b c d e
	Letters and numbers (with accented letters)	é í ó ç ñ
	Numbers only	1 2 3 4 5
	Web address shortcuts	.com .ne .html .gif

### Hint

The language for the on-screen keyboard is linked to the System Language selected in System Settings (•▶ page 91). For example, if System Language is set to Japanese, the Japanese keyboard is displayed.

## Entering characters

This section will demonstrate how to enter text using the word "PLAY" as an example.

- 1 Select PQRS7, and then press the  button several times until "P" is displayed.**

Each time you press the  button, the character that is entered in the text entry field is switched.

- 2 Select JKL5, and then press the  button several times until "L" is displayed.**

- 3 Select ABC2, and then press the  button several times until "A" is displayed.**

- 4 Select WXYZ9, and then press the  button several times until "Y" is displayed.**

- 5 Select Enter, and then press the  button.**

The characters you entered will be confirmed. Select Enter again, and press the  button to exit the keyboard.

### Hint

If you select the a/A key while entering characters, you can switch between upper and lower case.

## Additional information

# PSP™ updates

By updating the PSP™ system software, you can change or add features.

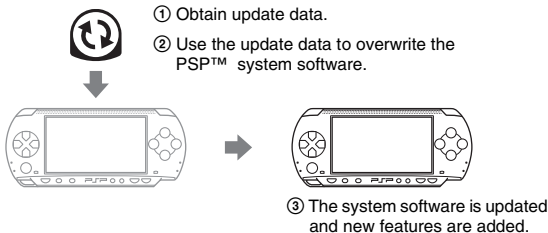

You can perform an update in any of the following ways:

- Network Update
- Update using a PC
- Update using a UMD™

Select the update method that works best for you. For the latest information on updates, visit

<http://www.sceh.com.hk> (Hong Kong, Southeast Asia)

<http://www.sceh.com.tw> (Taiwan)

## Network Update

Update using the PSP™ system's wireless networking feature. For detailed instructions, see "Network Update" (▶▶ page 111).

## Update using a PC

Update method using a PC to download update data from the Internet. For detailed instructions, visit

<http://www.sceh.com.hk> (Hong Kong, Southeast Asia)

<http://www.sceh.com.tw> (Taiwan)

GB

Additional information

## Update using a UMD™

You can update using a UMD™ that contains update data.  
Before starting, check that the battery is charged.

### Notice

During an update:

- do not remove the UMD™
- do not turn off the system
- do not disconnect the AC adaptor

The system software may be damaged if the update is interrupted.

### 1 Connect the AC adaptor to the PSP™ system.

If the AC adaptor is not connected, the update data cannot be started.

### 2 Insert a UMD™ that contains update data.

The update data icon and version number are displayed under  in the home menu.



### 3 Select , and then press the button.

The update begins. Follow the on-screen instructions to complete the update.

## Check that the update was successful

If the version number of the update is displayed in the "System Software" field under "System Information" (•▶ page 93), the update was successful.

## Compatible media

The media types listed below can be used on the PSP™ system. Throughout this manual, the term "Memory Stick Duo™" is used to refer to all types of Memory Stick™ media in the table below.

Type	Logo
UMD™	
Memory Stick Duo™ (not MagicGate™-compatible)	
MagicGate™ Memory Stick Duo™ *1	
Memory Stick Duo™ (MagicGate™ compatible) *1 *2	
Memory Stick PRO Duo™ *1 *2	

\*1 Compatible with MagicGate™

\*2 Compatible with high-speed data transfer over a parallel interface. The actual data-transfer speed will vary depending on the Memory Stick Duo™-compatible device.

### Hints

- Performance of all Memory Stick™ media is not guaranteed.
- If a Memory Stick Duo™ is formatted in a device other than the PSP™ system, such as a PC, it is possible that the system will not recognize it. If this happens, re-format the Memory Stick Duo™ using the PSP™ system (\*\*▶ page 92).

## UMD™

UMD™ contain a region code that is assigned to each sales region. This system can play UMD™ marked with either region code "ALL" or "3".



## Memory Stick™

There are two sizes of Memory Stick™: the standard size and the smaller size. The PSP™ system is compatible with Memory Stick Duo™, the smaller sized type. The standard-size Memory Stick™ cannot be used with the system.

### Memory Stick Duo Adaptor



The Memory Stick Duo Adaptor (MSAC-M2: a Sony product sold separately) allows a Memory Stick Duo™ to be used with devices that take a standard-size Memory Stick™.

### MagicGate-compatible Memory Stick Duo™



The MagicGate-compatible Memory Stick Duo™ has been designed with an indented area (see figure **A**) to allow it to be differentiated by touch from the standard Memory Stick Duo™.

### MagicGate

**MAGICGATE** is a term of copyright-protection technology developed by Sony Corporation.

**MAGICGATE** does not guarantee compatibility with other products bearing the "MagicGate" trademark.

### Parallel data transfer (high-speed data transfer)

Parallel data transfer is a high-speed data-transfer technology that allows multiple data input/output connectors on the Memory Stick™ to be used at the same time (parallel interface).



## Files that can be played

You can play files of the following types on the PSP™ system:

Content category	File types
Video	-MP4 (video codecs for video files that conform to the Memory Stick™ video file format are MPEG-4 or AVC)
Music	-Memory Stick™ audio file format (ATRAC3™/ATRAC3plus™) -MP3 -MP4 (the audio codec for MP4 format audio files is MPEG-4 AAC) -WAV (Linear PCM)
Photo	-JPEG (conforms with DCF2.0/Exif2.21) -TIFF -GIF -PNG -BMP

### Hint

Depending on the data type, some data items cannot be played.

# Specifications

Design and specifications are subject to change without notice.

## PSP™ (PlayStation®Portable)

LCD screen	4.3 inches (16:9) full-transparent type, TFT drive Approximately 16,770,000 colors displayed
Sound	Stereo speakers
Internal disc drive	Read-only UMD™ drive
Interface	DC IN 5V connector Charging terminals Headset connector IR port Hi-speed USB DC OUT connector Memory Stick Duo™ slot Wireless LAN (IEEE 802.11b)
Compatible codecs	Video -UMD™: H.264/MPEG-4 AVC Main Profile Level3 -Memory Stick™: MPEG-4 SP(MPEG-4 AAC), H.264/MPEG-4 AVC Main Profile(MPEG-4 AAC)
	Music -UMD™: H.264/MPEG-4 AVC Main Profile Level 3, Linear PCM, ATRAC3plus™ -Memory Stick™: ATRAC3plus™, MP3 (MPEG1/2 Audio Layer3), Linear PCM(WAV form), AAC(MP4 form)
	Photo -Memory Stick™: JPEG (conforms with DCF2.0/Exif2.21), TIFF, GIF, PNG, BMP
Power source	AC adaptor: DC 5.0 V Rechargeable battery pack: Lithium-Ion rechargeable battery pack

Battery duration	See page 38
Maximum power consumption	Approx. 6 W (when charging)
External dimensions	Approx. 170 × 74 × 23 mm / 6 <sup>3</sup> / <sub>4</sub> × 3 × 1 in (width × height × depth) (excludes largest projection)
Weight	Approx. 280 g (including battery pack)
Operating environment temperature	5°C - 35°C/41°F - 95°F

### UMD™ laser

Wave length	655-665 nm
Power	max 0.28 mW
Type	Semiconductor, continuous

### Wireless networking

Standard	IEEE 802.11b
WEP	128-bit/64-bit
Modulation format	DS-SS (IEEE 802.11b compliant)

### AC adaptor

Input	AC 100-240 V, 50/60 Hz
Output	DC 5 V, 2000 mA
External dimensions	Approx. 46 × 22 × 76 mm / 1 <sup>4</sup> / <sub>5</sub> × <sup>4</sup> / <sub>5</sub> × 3 in (width × height × depth) (excludes largest projection)
Weight	Approx. 100 g

## Battery pack

Battery type	Lithium-ion rechargeable battery
Voltage	DC 3.6 V
Capacity	1800 mAh

## Contents

See page 16.

### ■ Memory Stick Duo™

The supplied Memory Stick Duo™:

- is compatible with MagicGate™.
- is able to perform parallel data transfer (high-speed data transfer). This type of high-speed data transfer can be used only with compatible devices. Transfer speed will vary depending on the device used.
- includes capacity that can actually be used (user capacity) and space reserved for system files. The user capacity of the supplied product is approximately 30 MB.

## Software

Software developed by the NetBSD Foundation, Inc. and its contributors is used for the communication functions of this product. For more information, see <http://www.scei.co.jp/psp-license/pspnet.txt>

This product adopts S3TC texture compression technology under license from S3 Graphics, Co., Ltd.

This product includes RSA BSAFE Cryptographic software from RSA Security Inc. RSA is a registered trademark of RSA Security Inc. BSAFE is a registered trademark of RSA Security Inc. in the United States and/or other countries.

U.S. and foreign patents licensed from Dolby Laboratories.

MPEG Layer-3 audio coding technology and patents licensed from Fraunhofer IIS and Thomson.

This product contains **NetFront™** Internet browser software of ACCESS Co., Ltd.

Copyright © 1996-2005 ACCESS Co., Ltd.

**NetFront™** is a trademark or registered trademark of ACCESS Co., Ltd. in Japan and other countries.

Portions of the PSP™ system software requires the following notices:

This software is based in part on the work of the Independent JPEG Group.

Copyright © 1988-1997 Sam Leffler

Copyright © 1991-1997 Silicon Graphics, Inc.

Permission to use, copy, modify, distribute, and sell this software and its documentation for any purpose is hereby granted without fee, provided that (i) the above copyright notices and this permission notice appear in all copies of the software and related documentation, and (ii) the names of Sam Leffler and Silicon Graphics may not be used in any advertising or publicity relating to the software without the specific, prior written permission of Sam Leffler and Silicon Graphics.

THE SOFTWARE IS PROVIDED "AS-IS" AND WITHOUT WARRANTY OF ANY KIND, EXPRESS, IMPLIED OR OTHERWISE, INCLUDING WITHOUT LIMITATION, ANY WARRANTY OF MERCHANTABILITY OR FITNESS FOR A PARTICULAR PURPOSE.

IN NO EVENT SHALL SAM LEFFLER OR SILICON GRAPHICS BE LIABLE FOR ANY SPECIAL, INCIDENTAL, INDIRECT OR CONSEQUENTIAL DAMAGES OF ANY KIND, OR ANY DAMAGES WHATSOEVER RESULTING FROM LOSS OF USE, DATA OR PROFITS, WHETHER OR NOT ADVISED OF THE POSSIBILITY OF DAMAGE, AND ON ANY THEORY OF LIABILITY, ARISING OUT OF OR IN CONNECTION WITH THE USE OR PERFORMANCE OF THIS SOFTWARE.

## Trademarks

"PS" is a registered trademark, and "PS2" and "UMD" are trademarks of Sony Computer Entertainment Inc.

"PS2" and "XMB" are trademarks of Sony Corporation and Sony Computer Entertainment Inc.

"SONY" is a registered trademark, and "SONY" is a trademark of Sony Corporation. Also, "Memory Stick Duo", "Memory Stick PRO Duo", "Memory Stick", "", "SonicStage", "MagicGate", "ATRAC3plus" and "ATRAC3" are trademarks of the same company.

ATOK is a registered trademark of JUSTSYSTEM CORP in Japan and other countries.



Windows is a registered trademark or a trademark of Microsoft Corporation in the U.S. and other countries.

Mac OS is a registered trademark of Apple Computer in the U.S. and other countries.

All other trademarks are the properties of their respective owners.

## About national export control

This product may fall within the scope of national export control legislation. You must comply fully with the requirements of such legislation and of all other applicable laws of any jurisdiction in relation to this product.

# Troubleshooting

Go through this section if you experience difficulty in operating the PSP™ system. Should any problem persist, call the PSP™ service line at the number listed on your warranty card for assistance.

## Power, battery and charging issues

---

### The power does not turn on.

- ➔ Check that the battery is charged (➔ page 37).
- ➔ Check that the battery pack is properly inserted (➔ page 23).

---

### The battery does not charge, or does not fully recharge.

- ➔ Check that the AC adaptor and the AC power cord are properly inserted in the system and the electrical outlet.
- ➔ Check that the WLAN function is not in use while charging. The battery cannot be recharged when the WLAN function is in use.
- ➔ Check that the correct AC adaptor for this product is being used.
- ➔ Check that the AC adaptor connector is clean. If not, wipe it with a dry, soft cloth.
- ➔ If charging the battery in an extremely cold location, it may take longer to fully charge the battery.
- ➔ There may be a problem with the battery pack. Try using a replacement battery pack that is marked for use with the PSP™ system, if available.

---

### The battery charge doesn't last long.

- ➔ When using the system in extremely hot or cold locations, the charge may not last as long. Try to avoid using the system in such environments.
- ➔ There may be a problem with the battery pack. Try using a replacement battery pack that is marked for use with the PSP™ system, if available.

---

**The power indicator is on, but the LCD screen is not displayed.**

- ➔ Check that the LCD screen's backlight is not turned off. If it is, press any of the system buttons to turn on the backlight.

---

**The battery loses its charge even when the system is turned off.**

- ➔ Because battery power is used even when the system is turned off, it is recommended that you charge the battery frequently.

## Screen

---

**The screen suddenly turns dark.**

- ➔ Check the Backlight Auto-Off setting. If it is set to on, the backlight will turn off after the set period of time. Press any of the system buttons to turn on the screen (➔ page 96).
- ➔ Check the Auto Sleep setting. If it is turned on, the screen will turn dark after the set period of time (➔ page 97).

---

**The screen is dark and hard to see.**

- ➔ The screen may appear dark, depending on the angle of viewing. Use the display button on the system front to adjust the brightness (➔ page 36).

---

**The black, red, blue and green spots on the screen do not disappear.**

- ➔ LCD screens are made with highly precise technology, but in some cases, black spots may appear, or red, blue or green spots may remain on the screen. This is not a malfunction. For details see "Precautions" (➔ page 9).

---

**The color of the screen does not look right.**

- ➔ If "Theme" is set to "Original", the background color automatically changes at the beginning of each month (➔ page 94). The system is set to "Original" at the time of purchase.



---

### There is no sound.

- ➔ Check that the volume is not set to zero. Try raising the volume (➔ pages 18, 22).
- ➔ Check that the mute setting is not on. Press the sound button on the system front to clear the mute setting (➔ page 34).
- ➔ If headphones are inserted, the system will not produce any sound through the speakers.
- ➔ See also "There is no sound or the sound quality from the headphones is poor." (➔ page 133).

---

### The volume does not turn up.

- ➔ Check that the AVLS feature is turned off. When turned on, the AVLS feature limits the maximum volume of the headphones (➔ page 98).

---

### Sound quality is poor.

- ➔ If the system is used in an area where there are vibrations, or if it is near strong magnetic objects such as a television, the sound may be distorted and there may be increased background noise. Try moving the system to a different location.

---

### The system does not recognize the UMD™.

- ➔ Check that the UMD™ is properly inserted (label is facing the system rear, etc.). Try taking out the UMD™ and reinserting it.
- ➔ Check that the UMD™ recorded surface is clean. If not, wipe it gently with a soft cloth (➔ page 14).

---

### The UMD™ doesn't play properly.

- ➔ If moisture condensation occurs, remove the UMD™ from the system and do not use the system for several hours until the condensation evaporates (➔ page 13).

---

**Upon starting a UMD™, a message recommending an update is displayed.**

- ➔ Update the system software (➔ page 117).

---

## Memory Stick Duo™

---

**The Memory Stick Duo™ cannot be inserted.**

- ➔ Set the Memory Stick Duo™ in the proper direction when inserting (➔ page 32).

---

**The system does not recognize the Memory Stick Duo™.**

- ➔ If the Memory Stick Duo™ was formatted by a PC, the system may not recognize it. After copying important data to your PC, re-format the Memory Stick Duo™ using the system. For details, see "Format Memory Stick™" (➔ page 92).
- ➔ Check that the Memory Stick Duo™ is properly inserted. Try taking out the Memory Stick Duo™ and reinserting it.
- ➔ Check that the Memory Stick Duo™ connector is clean. If not, the data may not load properly. Wipe the connector with a cotton swab.

---

**The system can't save or load data.**

- ➔ Check that there is sufficient free space on the Memory Stick Duo™ to save data (➔ page 43).
- ➔ There may be a problem with the Memory Stick Duo™. Try using another Memory Stick Duo™, if available.

---

## Video

---

**The UMD™VIDEO does not operate.**

- ➔ If the playback conditions have been set by the software developer, the UMD™VIDEO may not play as described in this manual.

---

**Videos do not play.**

- ➔ Depending on the bit rate, certain videos may not be playable on the system. Check that the video files were converted at a bit rate of 768 kbps or lower.

---

**The system does not recognize a video data item.**

- ➔ Video data of types that are not compatible with the system will not be recognized (➔ page 121).
- ➔ If the file or folder name on the Memory Stick Duo™ is changed, or if the file or folder is moved to another location using a PC, the system may not recognize it.

---

**Music**

---

**Music does not play.**

- ➔ Tracks with an expiration date or a limited number of playing times may not be playable on the system.
- ➔ When playing ATRAC3plus™ data, software compatible with copyright-protection features must be used to transfer the data onto a Memory Stick Duo™ (➔ page 67).

---

**Tracks from other groups do not play.**

- ➔ Check that the Group Mode feature is turned off. When turned on, tracks from only one group can be played.

---

**The system does not recognize music data.**

- ➔ Check that the music data is saved in the correct folder on the Memory Stick Duo™ (➔ page 69).
- ➔ Music data of types that are not compatible with the system will not be recognized (➔ page 121).

---

**A group on a Memory Stick Duo™ cannot be deleted.**

- ➔ If there is non-music data in the group, the group cannot be deleted.

## Photo

---

### **Images do not display.**

- ➔ Depending on the image data size, certain images are not viewable.
  - ➔ If images are edited using a PC, they may not be viewable.
- 

### **The system does not recognize the image data.**

- ➔ Check that the data is saved in the correct folder on the Memory Stick Duo™ (➔ page 83).
  - ➔ If the file or folder name on the Memory Stick Duo™ is changed, or if the file or folder is moved to another location using a PC, the system may not recognize it.
  - ➔ Images that are not compatible with the PSP™ system will not be recognized (➔ page 121).
- 

### **A folder on a Memory Stick Duo™ cannot be deleted.**

- ➔ If there is non-image data in the folder, the folder cannot be deleted.
- 

## Network

---

### **A connection to the network cannot be established.**

- ➔ Check that the WLAN switch on the left side of the system (➔ page 21) is turned on.
- ➔ Set the WLAN Power Save mode to Off (➔ page 97). This will allow the system to communicate at full power.
- ➔ There may be too much distance between the system and the access point or the system and the other player.
- ➔ Check that the network settings (➔ page 104) are correct. Refer to the instructions supplied with the network equipment and by your Internet service provider to make the correct network settings.
- ➔ Depending on the access point setting, you may need to enter the system's MAC address (➔ page 93).
- ➔ When communicating with another system in ad hoc mode, both systems must be set to the same channel (➔ page 104).

---

### **The Web page won't display properly**

- ➔ Some Web pages may not display properly.

---

## **Headphones with remote control**

---

### **There is no sound or the sound quality from the headphones is poor.**

- ➔ Check that the headphones are fully inserted into the system (➔ page 26).
- ➔ Check that the headset connector and the headphone plug are clean. If not, wipe them with a dry, soft cloth. See also "There is no sound".

---

### **The remote control does not work.**

- ➔ Check that the headphones are fully inserted in the system (➔ page 26).
- ➔ Check that the remote control is not in hold mode. If it is, clear hold mode (➔ page 22).

---

## **Other issues**

---

### **The system or AC adaptor is warm.**

- ➔ During use, the system or AC adaptor may become warm. This is not a malfunction.

---

### **The system is turned on, but does not operate.**

- ➔ Check that the system is not in hold mode. If it is, slide the power/hold switch up to clear hold mode (➔ page 33).
- ➔ Try sliding the power/hold switch up and holding until the power indicator turns off. The system will be completely turned off. Then turn on the system again.

---

### **The system does not function properly.**

- ➔ Static electricity and other similar occurrences may affect the system's operation. Remove the battery pack and AC adaptor, wait for about 30 seconds, and then restart the system.

---

**When the buttons are pressed, there are no key tones.**

- ➔ Check that the Key Tone feature is turned on (➔ page 98).

---

**The date and time are reset.**

- ➔ If the battery is not recharged and runs out, or if the battery pack is replaced, the system date and time settings may be reset. Follow the on-screen instructions to set the time and date.

---

**The PSP™ system is not recognized by the PC when connected using a USB cable.**

- ➔ When using a USB hub or other devices, depending on the operating environment of the PC, the Memory Stick Duo™ inserted in the system may not be recognized by the PC. Try connecting the system directly to the PC using a USB cable.

---

**You forgot your password.**

- ➔ If you restore the system settings to the settings at the time of purchase, the password will return to "0000". For details, see "Restore Default Settings" (➔ page 93). Note that if you restore your settings, settings other than the password will also be lost. Once these settings are lost, they cannot be recovered.

# WARRANTY

Refer to the enclosed document for region-specific warranty information.

GB

Additional information

## 光敏感

有極少部分的人，可能會於接觸閃光或強烈光線照射時，出現癲癇發作的症狀。此類型的人們有時會因觀看電視機的動態影像或靜止畫面，或是遊玩遊戲機（包括 PSP™）而引發癲癇發作。即使至今未曾有過類似發作經驗的人，亦有遭遇上述症狀之可能。若您或您家族的任何人曾經有過癲癇發作的經驗，請於開始遊玩前，先詢問您的家庭醫生。如果您在遊玩家用遊戲時曾經出現下列症狀：感覺眼花撩亂、視力模糊、眼睛或肌肉感覺疼痛、喪失知覺、迷失方向感、無意識地行動或全身痙攣時，請立刻中止遊玩並於繼續遊玩前先詢問您的家庭醫生。

## 無線電波

無線電波可能會影響電子設備或醫療裝置（例如心律調整器），且可能會導致這些設備或裝置故障或損壞。

- 若您有使用心律調整器或其他醫療裝置，請在使用無線網路功能之前先詢問您的主治醫生或您身上之醫療裝置的製造廠商。
- 使用無線網路功能時，請讓 PSP™ 主機與心律調整器或其他醫療裝置之間保持至少 23 公分（9 吋）的距離。
- 請勿在下列場所使用無線網路功能：
  - 禁止使用的場所，例如飛機或醫院中。在醫院中使用 PSP™ 主機時請遵守醫院的規定。此外，在飛機中使用無線網路功能或是於飛機起降時使用 PSP™ 之行為，可能會導致您因為違反航空安全規定而受到嚴厲的懲罰。
  - 擁擠的場所。
  - 接近火災警報器、自動門或其他類型之自動化設備的場所。
- 由於無線電波可能會干擾某些汽車的電子裝備，於車內使用無線網路功能時務必小心使用。



廢電池請回收  
(僅適用於台灣)



## 以下規定僅適用於台灣

根據 交通部電信總局低功率電波輻射性電機管理辦法規定：

### 第十二條

經型式認證合格之低功率射頻電機，非經許可，公司、商號或使用者均不得擅自變更頻率、加大功率或變更原設計之特性及功能。

### 第十四條

低功率射頻電機之使用不得影響飛航安全及干擾合法通信；經發現有干擾現象時，應立即停用，並改善至無干擾時方得繼續使用。

前項合法通信，指依電信法規定作業之無線電通信。

低功率射頻電機須忍受合法通信或工業、科學及醫療用電波輻射性電機設備之干擾。



## 遊戲

→ 第 173 頁

- 玩遊戲
- 管理保存資料



## 影像

→ 第 177 頁

- 播放 UMD™VIDEO
- 播放保存在 Memory Stick Duo™ 內的影像



## 音樂

→ 第 190 頁

- 播放 UMD™MUSIC
- 播放保存在 Memory Stick Duo™ 內的音樂



## 相片

→ 第 203 頁

- 顯示保存在 Memory Stick Duo™ 內的圖像
- 播放幻燈片秀



## NETWORK (網路)

→ 第 216 頁

- 與網路連線



## 設定

→ 第 218 頁

- 調整 PSP™ 主機設定
- 新建影像、相片或網路設定
- 利用 USB 連接埠連接其他裝置

## 使用自家選單

PSPTM 主機的基本操作皆從自家選單 (home menu) 起步。按下 HOME (歸返) 按鈕開啟自家選單後，可使用方向按鈕水平或垂直瀏覽圖示列。

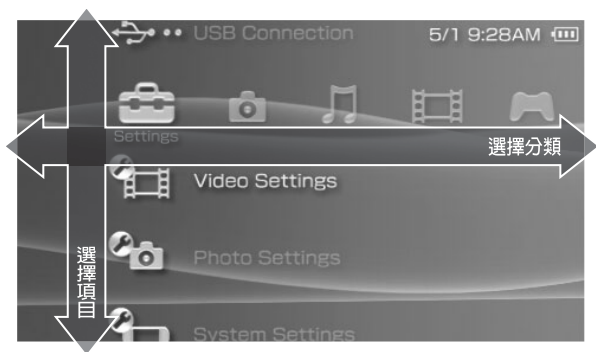

## 基本按鈕操作

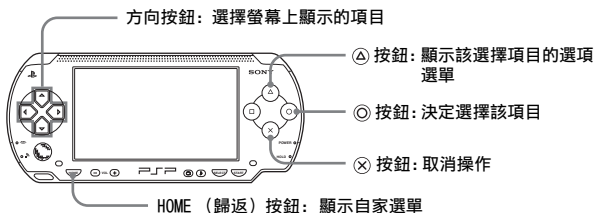

# 目錄

警告 .....	136
使用前須知事項 .....	143
電池組注意事項 .....	148

---

## ■ 準備工作

檢查各項配件 .....	149
各部名稱與功能 .....	151
使用 PSP™ 主機的事前準備 .....	156
連接線控裝置與耳機 .....	159

---

## ■ 基本操作

打開和關閉 PSP™ 主機電源 .....	160
離開睡眠模式 .....	162
插入 UMD™ .....	164
插入 Memory Stick Duo™ .....	165
避免 PSP™ 主機的錯誤操作 .....	166
使用聲音按鈕 .....	167
使用顯示按鈕 .....	169
電池 .....	170

---

## ■ 遊戲

玩遊戲 .....	173
遊戲選項選單 .....	175
拷貝及刪除保存資料 .....	176

---

## ■ 影像

觀賞影像 .....	177
使用控制介面 .....	179
利用 PSP™ 主機的按鈕或線控裝置進行操作 .....	186
影像選項選單 .....	187
將影像保存至 Memory Stick Duo™ .....	188

---

■ 音樂	
聽音樂	190
使用控制介面	193
利用 PSP™ 主機的按鈕或線控裝置進行操作	197
音樂選項選單	198
將音樂傳送並保存至 Memory Stick Duo™	200

---

■ 相片	
瀏覽圖像	203
使用控制介面	204
利用 PSP™ 主機的按鈕或線控裝置進行操作	208
相片選項選單	209
播放幻燈片秀	211
將圖像保存至 Memory Stick Duo™	214

---

■ 網路	
連接網際網路 (互聯網)	216

---

■ 設定	
PSP™ 主機的設定	218
Video Settings (影像設定)	220
Photo Settings (相片設定)	221
System Settings (系統設定)	222
Theme Settings (主題設定)	225
Date & Time Settings (日期 & 時間設定)	226
Power Save Settings (省電設定)	227
Sound Settings (聲音設定)	229
Security Settings (安全性設定)	230
USB Connection (USB 連接)	233
Network Settings (網路設定)	235
Network Update (網路更新)	242
如何使用鍵盤	245

---

## ■ 其他資訊

PSP™ 更新 .....	247
相容媒體 .....	249
規格 .....	252
故障檢修 .....	257
維修責任 .....	264

# 使用前須知事項

使用本機以前，請先詳細閱讀本說明書，並妥善保存，以備將來參考之用。

## 關於安全

本產品是在充分重視安全性能的情況下設計的。但如果使用不當，任何電器產品都有可能引起火災觸電或人身傷害的潛在危險。為確保安全操作，請遵循以下各項規則：

- 遵守所有警告條文注意事項及使用說明。
- 定期檢查交流電轉換器與交流電源線是否有損壞，以及電源插頭或電源插座有沒有灰塵堆積。
- 如果裝置出現動作不正常，或者發出異常聲音或氣味時，請立即停止使用，並從電源插座中拔掉交流電源線插頭及所有的其他連接線。
- 如果 PSP™ 出現故障情形，請聯絡保證書上記載的 PSP™ 消費者服務中心，以取得必要協助。

## 使用和保養

- 請在光線良好的地方使用本機，並與螢幕保持一段安全距離。
- 避免長時間使用 PSP™ 主機。為了避免眼睛疲勞，每玩一小時請休息 15 分鐘。
- 若您有遭遇下列健康問題，請立即停止使用主機。如果不良症狀持續存在，請立即就醫。
  - 頭昏眼花，噁心、疲勞或類似暈船感覺
  - 當眼睛、耳朵、手臂、手腕等，身體一部分感覺不舒服或疼痛時。
- 請將主機與附屬品放在兒童拿不到的地方保管。  
兒童可能會吞下 Memory Stick Duo™ 或用連接線、吊繩纏繞自己，而造成身體損傷或導致意外發生、機器故障。
- 請勿在開車或騎腳踏車時使用。開車或騎腳踏車時觀看螢幕或操作主機可能會導致發生交通意外。
- 邊走邊使用主機時請務必特別小心。
- 關上光碟蓋時請小心不要夾到手指。
- 切勿在靠近水的場所使用主機或附屬品。
- 請只使用製造廠商指定的附屬品 / 周邊機器。

- 當耳機對您的皮膚造成不適時，請勿繼續使用。  
若隨附的耳機對您的皮膚造成不適時，請立即停止使用。若停止使用之後，狀況仍舊沒有改善，請立即就醫。
  - 請勿將主機或附屬品放在高溫、濕氣極重或受日光直射的地方。
  - 請勿將主機或附屬品放在窗戶密閉的車內（特別是夏天）。
  - 請勿將主機或附屬品暴露在灰塵、煙霧或蒸氣中。
  - 請勿讓液體或小顆粒掉入主機或附屬品中。
  - 請勿將主機或附屬品放在傾斜、不平整或易受振動的地方。
  - 請勿投擲或掉落主機或附屬品，或使它們受到強烈的外力撞擊。請小心持用類比墊。
  - 請勿於遊玩時強制扭轉 PSP™ 主機或使主機受到強烈外力撞擊，否則可能會損壞主機或導致光碟蓋開啟及射出光碟。
  - 請勿在主機或附屬品上放置重物。
  - 請勿觸摸、或將異物插入主機或附屬品的端子部分。
  - 請勿將主機放置在信用卡等帶磁帶的物體附近。
  - 使用主機時請勿長時間碰觸主機或交流電轉換器。主機或交流電轉換器的溫度可能隨使用狀況而達到 40°C/104°F 或更高的溫度。在此情況下的長時間接觸可能會導致低溫灼傷\*。
- \* 當皮膚與相對低溫（40°C 或以上 / 104°F 或以上）的物體長時間接觸時，便會產生低溫灼傷。

## 關於交流電轉換器和交流電源線的使用

- 請勿用濕手觸摸交流電源線的端子。
- 請勿在雷雨天氣中，觸摸正連接至電源插座的交流電源線、交流電轉換器或主機本身。
- 除指定的電池組，交流電轉換器和交流電源線以外，切勿使用其他電源。
- 請勿讓灰塵或異物堆積於主機或附屬品等周邊機器的端子四周。若發現有灰塵或異物堆積於主機端子的四周或是交流電源線上，請在連接前使用乾淨軟布擦拭。堆積於連接端子上的灰塵或其他異物可能會導致火災或造成觸電。
- 於您準備開始清潔或打算長時間不使用主機時，請自電源插座中拔出交流電源線，並從主機中取出電池組。
- 請避免踩到或招擠交流電源線，尤其是插頭、轉接用的便利插座與電源線等自主機延伸出來的組件更需注意。
- 在拔下交流電源線時，請捉住電源插頭筆直地將插頭從電源插頭拔出。絕不能拉扯連接線或強制朝特定方向拔取。



- 請勿於使用布等物品覆蓋主機時遊玩遊戲或觀賞影像。假如您想於遊玩遊戲或觀賞影像時暫停或暫時收起主機，請在放入收藏包前，先讓主機進入睡眠或固定模式。又，於使用布覆蓋主機時，請勿使用交流電轉換器，以避免主機出現過熱現象。
- 請勿將交流電源線插入變壓器或反相器。  
將交流電源線插入海外旅行者使用的變壓器或汽車專用的反相器，可能會導致交流電轉換器發熱，並造成灼傷或故障。

## 液晶畫面

- 液晶畫面上的某些特定位置可能會出現紅色、藍色或綠色點（亮點）或黑色點（暗點）。液晶畫面出現此類現象乃是正常現象，並非故障。液晶畫面係使用高精密度的技術製造。但每個畫面仍可能會殘存極少數的暗點或持續性的亮點。又，在關閉主機後，部分已消滅的影像仍可能於畫面上殘存數秒鐘。
- 直射的日光可能會損壞主機的液晶畫面。當於戶外或窗戶附近使用本主機時請務必小心。
- 在寒冷的環境中使用本機時，您可能會發現圖像出現陰影或畫面似乎顯得比平常陰暗。此非一種故障，且螢幕會於溫度上昇後恢復正常。
- 請勿讓畫面長時間顯示靜態影像。這可能會導致模糊的影像永遠殘留在畫面上。

## Memory Stick Duo™

為了達到最佳效果，請遵守下列指示：

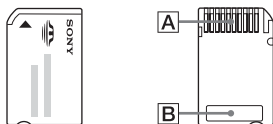

- 請勿用手或金屬物品碰觸連接端子部位（**A**）。
- 當於備忘區域（**B**）書寫時，請勿過度用力。
- 請勿將Memory Stick Duo™直接插入僅對應標準尺寸之Memory Stick™的裝置。
- 請勿以下述方法使用或放置Memory Stick Duo™：
  - 放置於溫度甚高之車內等高溫場所。
  - 受日光直射的場所。
  - 非常潮濕或有腐蝕危險的場所。
- 請使用隨附的攜帶盒來攜帶及保存Memory Stick Duo™。
- 當使用無防寫開關的Memory Stick Duo™時，請注意切勿意外而覆寫或刪除資料。假如您使用的是具防寫開關的Memory Stick Duo™，您可將開關調整至 LOCK（鎖定）位置，以避免資料因保存、編輯或刪除而流失。

## ■ 保存資料

請勿以下述方法使用 Memory Stick Duo™，否則可能會導致資料的遺失或毀損。

- 於載入、保存資料或進行格式化時，強硬取出 Memory Stick Duo™ 或關閉主機電源。
- 於帶有靜電或有電波干擾之區域使用。

無論理由為何，遊戲與資料一旦遺失或毀損，通常即已無法尋回該遊戲或資料。因此建議您應為遊戲與資料預留備份檔案。Sony Computer Entertainment Inc. 與其子公司、關係企業對於因遊戲或資料的遺失或毀損而造成之損害，概不承擔任何責任。

依據著作權法，在未取得著作權人同意前，除了個人娛樂用途外，任何錄製的資料皆不得用於其他用途。

## 收藏包與吊帶

- 假如您想於遊玩遊戲或觀賞影像時暫停或暫時收起主機，請在放入收藏包前，先讓主機進入睡眠或固定模式。如此可避免主機出現過熱現象。
- 請讓 PSP™ 主機與線控裝置進入固定（hold）模式以避免錯誤操作。
- 請將收藏包與吊帶放在兒童拿不到的地方保管。

## 切勿分解主機或提供的附屬品

請按照使用說明書來操作 PSP™ 主機與附屬品。嚴禁擅自分解或改造主機，禁止分解和使用其電路結構。擅自分解主機將喪失所有保障權益。此外，還有發生火災、觸電或主機故障的危險。尤其是液晶畫面的內部，其含有高電壓零件，非常危險。而且，讀取 UMD™ 的雷射光若直接照射到眼睛，可能會導致視力損傷。

## 在國外使用

因各國規定，部分國家可能會對特殊類型的無線電波有所限制。在某些情況下，使用本主機可能會被罰款或受到其他處罰。

## 結露現象

若把 PSP™ 主機或 UMD™ 從寒冷的地方直接搬到溫暖的場所，機內的透鏡或 UMD™ 上可能會凝結水氣。此種現象可能會導致主機無法正常運作。這時，請把 UMD™ 取出，關閉電源，並拔掉主機電源插頭。在水氣尚未蒸發之前，切勿再次放入 UMD™（水氣蒸發可能需要數小時）。如果主機仍無法恢復正常操作的話，請聯絡保證書上記載的 PSP™ 消費者服務中心，以取得必要協助。

## 持拿 UMD™

- 請勿用手觸摸光碟背面的開口部分（UMD™ 的記錄面）。
- 請注意不要讓灰塵、沙粒等異物或其他類型的塵埃進入或弄髒光碟。
- 當 UMD™ 出現污痕時，請使用擦拭眼鏡的乾淨軟布輕柔擦拭 UMD™ 的外殼表面與記錄面。切勿使用溶劑或其他化學藥劑。

## 清潔

為了安全著想，請在開始清潔前，先自電源插座中拔出交流電源線，並從主機中取出電池組。

### ■ 清潔外殼表面

以稍微沾濕的擦布擦拭，然後再將表面擦乾。請勿使用溶劑或其他化學藥劑來清潔 PSP™ 主機外殼。

### ■ 清潔液晶畫面

使用軟布輕柔擦拭。

### ■ 清潔連接端子

- 主機、交流電轉換器或交流電源線的連接端子若不乾淨，請勿繼續使用。請使用乾布或棉質紗布擦拭灰塵。若在髒污時使用，可能會妨礙電流的通過。
- 若耳機或線控裝置的連接端子出現污痕，可能會造成噪音或聲音出現中斷現象。此時請以乾淨軟布擦拭，以維持清潔乾淨。

# 電池組注意事項



請勿使用已損壞或電解液外洩的電池組。

碰觸這些有毒物質可能會導致眼睛或皮膚受到損傷或傷害。即使這些有毒性化學物質非為即時性的危險，仍可能因為物質的化學變化而於日後造成損傷。

假如您不慎碰觸了這些電解液外洩的電池組排出的有毒物質，請即刻採取以下行動。

- 當有毒物質進入眼睛時，勿用手揉眼睛。應立即用乾淨清水沖洗眼睛並接受醫生的診療。
- 當有毒物質滲入皮膚或衣服時，應立即用乾淨清水沖洗遭滲入部位。若引起發炎或疼痛，請迅速詢問您的家庭醫生。

請細心保管電池組。

若不留意保管，本電池組可能會引發爆炸或導致火災、化學傷害。

- 請勿將電池組放置於接觸火、受日光直射或曝露於太陽下、接近熱源的高溫場所。
- 請勿造成電池組短路。
- 請勿分解或擅自開啟電池組。
- 為避免對電池組造成損害，請勿與硬幣或鑰匙等金屬物品一同攜帶或保管電池組，否則可能會造成無法繼續使用的永久性損害。
- 請勿投擲、掉落電池組，且不可使其受到強烈的外力衝擊。
- 請勿在電池組上放置重物或施加重壓。
- 請勿讓液體掉落至電池組。沾有濕氣的電池組在完全變乾前都不得繼續使用。
- 請將電池組放在兒童拿不到的地方保管。
- 若長時間不使用 PSP™ 主機，請取出電池組並放置在陰涼、乾燥且兒童拿不到的地方保管。
- 請只使用指定的電池組或搭配 PSP™ 提供選購的組件。
- 請只使用指定的交流電轉換器替電池組充電。

## 檢查各項配件

請檢查和確認箱子內是否具備以下物品：如果欠缺任何物品，請打電話給保證書上記載的 PSP™ 消費者服務中心。

- PSP™ (PlayStation®Portable)

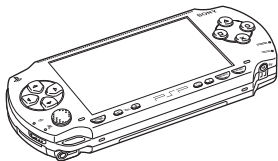

- 電池組



- 線控裝置與耳機

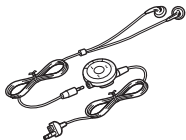

- 交流電轉換器



- 交流電源線 (附 3 插針電源插頭轉換器) (提供 PSP-1006 K 使用)

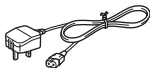

- Memory Stick Duo™ (32MB)

- 吊帶

- 收藏包

- 擦布

- 說明書等

- 交流電源線 (提供PSP-1007 K使用)



## 拆除 3 插針電源插頭轉換器（僅限 PSP-1006 K）

電源插座的形狀因地區而異。若預裝於交流電源線上的插頭形狀與您府上的電源插座不相容時，請鬆開螺絲並拆掉電源插頭轉換器。

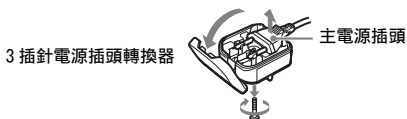

# 各部名稱與功能

## 主機前面

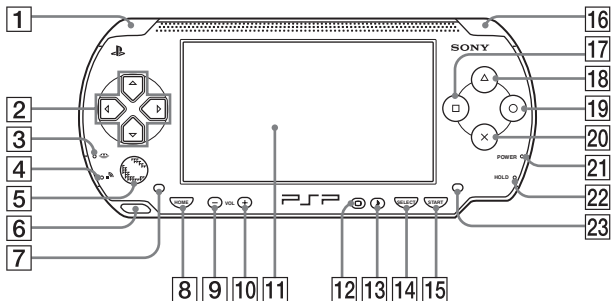

1 L 按鈕

2 方向按鈕

3 Memory Stick Duo™ 讀取燈  
會於保存 / 載入資料時不斷閃爍。

4 無線 LAN 顯示燈  
會於使用無線網路功能時不斷閃爍。

5 類比墊  
可於放入對應類比操作的遊戲時使用。

6 手繩固定勾  
以如圖所示的方式連接手繩。

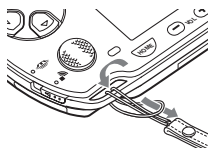

7 左喇叭

8 HOME (歸返) 按鈕  
顯示自家選單

9 音量 - 按鈕  
調低音量

10 音量 + 按鈕  
調高音量

CT

準備工作

- 11 液晶畫面
- 12 顯示按鈕  
調整畫面亮度 (●▶第 169 頁)
- 13 聲音按鈕  
調整音質 (●▶第 167 頁)
- 14 SELECT (選擇) 按鈕
- 15 START (開始) 按鈕
- 16 R 按鈕
- 17 □ 按鈕
- 18 △ 按鈕
- 19 ○ 按鈕
- 20 × 按鈕
- 21 POWER (電源) 指示燈  
可透過指示燈的亮燈、閃爍的顏色來了解主機狀態 (●▶第 160 頁)
- 22 HOLD (固定) 指示燈  
當主機處於 hold (固定) 模式時會變成黃色 (●▶第 166 頁)
- 23 右喇叭

## 主機背面

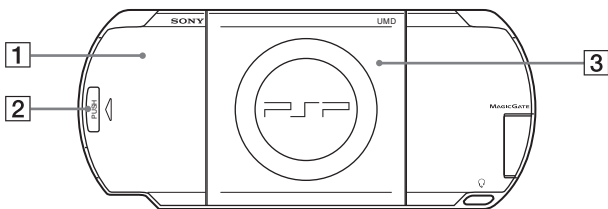

- 1 電池蓋
- 2 PUSH (推動) 按鈕
- 3 光碟蓋



## 主機上方

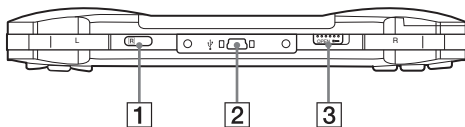

1 紅外線連接埠

3 OPEN（開啟）按鈕

2 USB 連接埠

## 主機下方

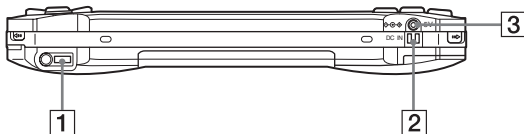

1 耳機 / 麥克風連接端

3 DC IN 5V 電源端子

2 充電用端子

## 主機左側

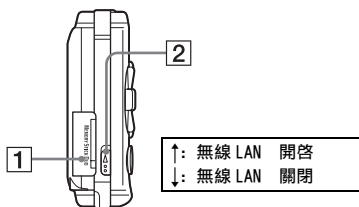

1 Memory Stick Duo™ 插口

2 無線 LAN 按鈕  
啟動無線網路功能

## 主機右側

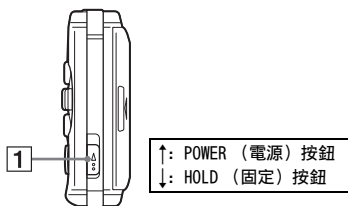

1 POWER (電源) /HOLD (固定) 按鈕

開啟及關閉主機，讓主機進入睡眠模式 (●▶第 160、162 頁) 以及鎖定主機的按鈕操作功能 (●▶第 166 頁)

## 線控裝置前面

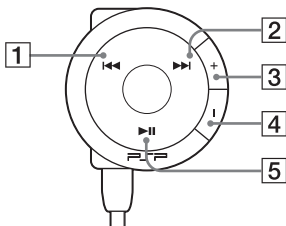

- 1 ◀◀ 按鈕
- 2 ▶▶ 按鈕
- 3 音量 + 按鈕  
調高音量
- 4 音量 - 按鈕  
調低音量
- 5 ▶|| 按鈕

## 線控裝置側面

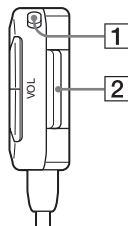

- 1 HOLD (固定) 按鈕  
鎖定線控裝置的操作功能。請注意，此按鈕並不會鎖定 PSP™ 主機按鈕的操作功能。
- 2 固定夾

# 使用 PSP™ 主機的事前準備

於購買並準備開始使用 PSP™ 主機前，您必須先依照下述步驟替電池充電。

## 準備 1：裝入電池組

### 1 拔起電池蓋。

按住 PUSH（推動）按鈕並將電池蓋推出。

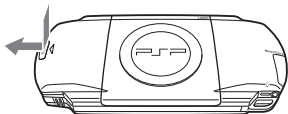

### 2 裝入電池組。

讓電池組的下方正確對準主機插入。

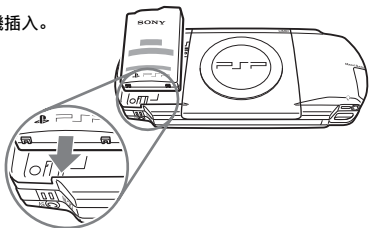

### 3 裝回電池蓋。

② 讓電池蓋向箭頭指示方向滑動，直到確實固定為止。

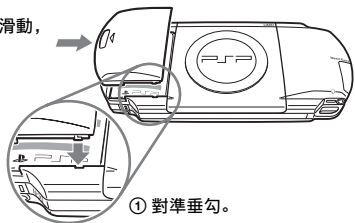

## 準備 2：充電

### ⚠ 注意

- 請插入接近且容易連接的電源插座。
- 在完成所有連接之前，請勿將 PSP™ 主機的交流電源線插頭插入電源插座。

### 1 將交流電源線連接至交流電轉換器。

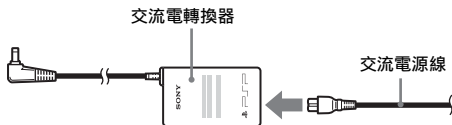

### 2 將交流電轉換器連接至主機下方的 DC IN 5V 電源端子。

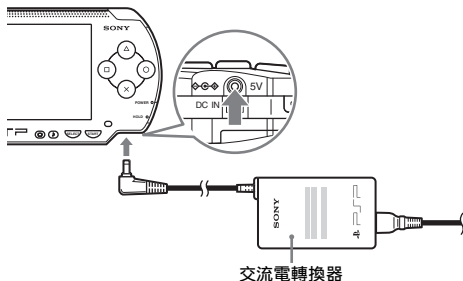

### 3 將交流電源線插頭插入電源插座。

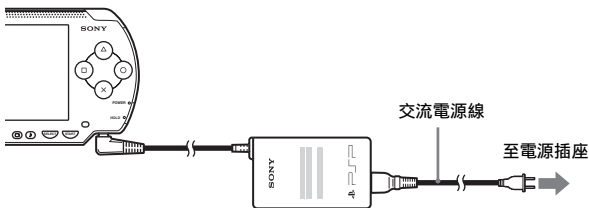

POWER（電源）指示燈會亮起橘色燈，表示開始為電池充電。在電池完全充飽電之後，POWER（電源）指示燈便會熄滅。

### 4 此時請將交流電源線從電源插座上拔下，並從主機拔下交流電轉換器。

#### 提示

若您想了解更多如何為電池充電的資訊，請參閱 "電池" 的說明 (●▶第 170 頁)。

## 準備 3：初始設定

### 1 開啟 PSP™ 主機的電源 (●▶第 160 頁)。

電源指示燈會亮起綠色燈，並顯示初始設定畫面。

### 2 請依照畫面指示設定 system language (系統語言)、time zone (時區)、date and time (日期與時間) 及 nickname (暱稱)。完成初始設定之後，即會顯示自家選單 (●▶第 139 頁)。

#### 提示

- 請參閱 "如何使用鍵盤" (●▶第 245 頁) 以了解如何輸入字元。
- 您可選擇  (Settings: 設定) 變更初始設定時設定的各項數值。詳細請參閱 "System Settings (系統設定)" (●▶第 222 頁) 與 "Date & Time Settings (日期 & 時間設定)" (●▶第 226 頁)。

# 連接線控裝置與耳機

## 1 將耳機連接至 PSP™ 主機。

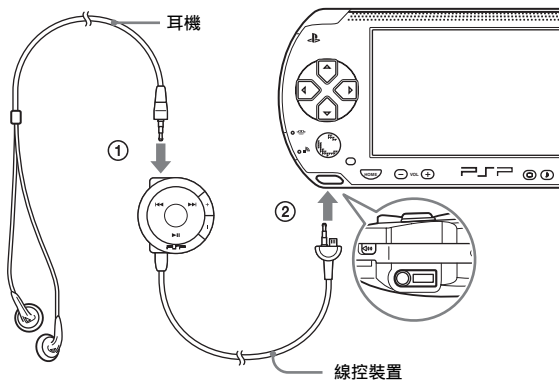

- ① 請將耳機插入線控裝置中。
- ② 將耳機插入主機下面的耳機 / 麥克風連接端。

### 提示

這套線控裝置乃 PSP™ 專用。請勿與其他產品併用。同時，其他裝置隨附的線控裝置也無法操作 PSP™ 主機。

## 打開和關閉 PSP™ 主機電源

### 打開主機電源

- 1 向上滑動 POWER（電源）/HOLD（固定）按鈕。

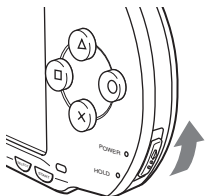

POWER（電源）指示燈會亮起綠色燈，並顯示自家選單。

#### 提示

- 若於放入 UMD™ 後打開 PSP™ 主機電源，則會自動開始播放 UMD™。
- 亦可在連接交流電轉換器後使用。此時，將會自動替電池充電。且 POWER（電源）指示燈會於充電時亮起橘色燈。
- 當未將電池組放入主機時，請勿併用 PSP™ 與交流電轉換器。若是突然拔掉交流電轉換器，可能會導致主機受損。

### POWER（電源）指示燈

燈光的顏色與狀態（持續或閃爍）會指示主機狀態。

持續綠色	電源打開
持續橘色	充電中
閃爍綠色	電池殘餘充電量低
燈光熄滅	電源關閉 / 進入睡眠模式



- 1 向上按住 POWER（電源）/HOLD（固定）按鈕超過三秒鐘。  
POWER（電源）指示燈於閃爍後熄滅，代表主機電源已被關閉。

## 離開睡眠模式

若將 PSP™ 主機切換為睡眠模式，將會暫時中斷正在遊玩的軟件。解除睡眠模式後，可自進入睡眠模式前的地點繼續遊玩或播放。

### 重要

- 請勿在 Memory Stick Duo™ 讀取燈亮起時讓主機進入睡眠模式，否則可能會導致資料的遺失或毀損。
- 若電池電力在睡眠模式中耗盡，那麼即使解除睡眠模式，螢幕亦不會返回進入睡眠模式前顯示的畫面。建議您在讓主機進入睡眠模式前保存遊戲資料。

## 離開睡眠模式

- 1 打開主機電源時，向上滑動 POWER（電源）/HOLD（固定）按鈕。

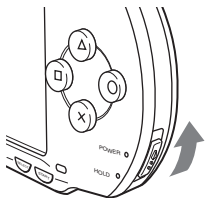

POWER（電源）指示燈於閃爍後熄滅，代表主機進入睡眠模式。

### 提示

部分軟件可能無法進入睡眠模式。

## 解除睡眠模式

- 1 再次向上滑動 POWER（電源）/HOLD（固定）按鈕。  
解除睡眠模式。

### 提示

- 當主機於播放音樂或影像途中進入睡眠模式時，您亦可按下線控裝置的 ►||（播放 / 暫停）按鈕，以解除睡眠模式。
- 於解除睡眠模式後，您可選擇自依循上述步驟進入睡眠模式前的播放點，繼續觀賞影像或聆聽音樂。

影像	於選擇影像圖示後，可選擇以下其中一種方法開始播放。 - 按下 START（開始）按鈕或 ◎ 按鈕。 - 按下線控裝置的 ►   按鈕。 - 選擇選項選單的 "Play（播放）"（▶▶ 第 187 頁）。
保存於 Memory Stick Duo™ 的音樂	於選擇 Memory Stick Duo™ 圖示後，可選擇以下其中一種方法開始播放。 - 按下 START（開始）按鈕。 - 按下線控裝置的 ►   按鈕。 - 選擇選項選單的 "Play（播放）"（▶▶ 第 198 頁）。

# 插入 UMD™

## 重要

請勿於播放中取出 UMD™。

- 1** 向右滑動 PSP™ 主機上方的 OPEN（開啟）按鈕。  
打開光碟蓋。
- 2** 插入 UMD™。  
讓光碟標籤面朝主機後方，將 UMD™ 向箭頭指示方向滑入直到完全插入為止。

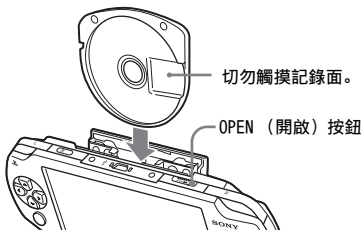

- 3** 關閉光碟蓋。

## 取出 UMD™

向右滑動主機上方的 OPEN（開啟）按鈕，打開光碟蓋。

### 提示

取出 UMD™ 時，請讓 PSP™ 維持按鈕朝上狀態（如圖）。

# 插入 Memory Stick Duo™



**警告**  
請將 Memory Stick Duo™ 放在兒童拿不到的地方保管，以避免不小心之誤食事故的發生。

## 1 打開插蓋並插入 Memory Stick Duo™。

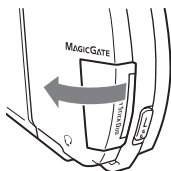

向箭頭指示方向打開插蓋。

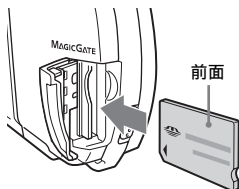

按下記憶卡直到記憶卡完全插入為止。

## 取出 Memory Stick Duo™

向箭頭指示方向打開插蓋並按下 Memory Stick Duo™，取出記憶卡。

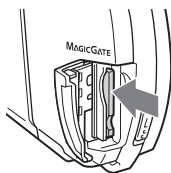

### 重要

當 Memory Stick Duo™ 讀取燈亮起時，代表 PSP™ 主機正在保存或載入資料。於此指示燈亮起時請勿取出 Memory Stick Duo™、關閉主機或讓 PSP™ 主機進入睡眠模式。否則可能會導致資料的遺失或毀損。

Memory Stick Duo™  
讀取燈

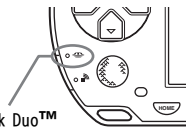

## 避免 PSP™ 主機的錯誤操作

- 1 向下滑動 POWER（電源）/HOLD（固定）按鈕。

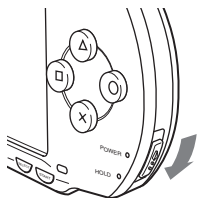

此按鈕便會固定在該位置。

HOLD（固定）指示燈亮起黃色燈，代表已鎖定主機的按鈕。

### 解除 hold（固定）模式

將 POWER（電源）/HOLD（固定）按鈕滑回原來的位置。

# 使用聲音按鈕

聲音按鈕是用來調整播放聲音與按鍵音的音質以及關閉聲音的按鈕。

## 調整音質

### 1 按聲音按鈕。

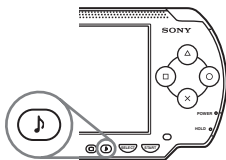

您每按一次此按鈕，都能依照下列順序變更音質：

HEAVY	強調低音域與高音域以創造魄力十足的音效
POPS	強調中音域，適合有歌聲的聲樂作品
JAZZ	強調低音域與高音域以創造均衡適切的音效
UNIQUE	強調低音域、高音域與中音域的音效
OFF	一般音質

#### 提示

唯有使用耳機時才能調整音質。且請注意，於玩遊戲時，音質會被暫時設定為"OFF"。

## 關閉聲音（靜音）

### 1 按住聲音按鈕一秒鐘以上。 聲音消失。

## 解除靜音

可透過下列方式關閉靜音功能：

- 按聲音按鈕。
- 按主機前面或線控裝置上的音量 + 或音量 - 按鈕。



# 使用顯示按鈕

顯示按鈕是用來調整畫面亮度的按鈕。

## 調整畫面亮度

### 1 按顯示按鈕。

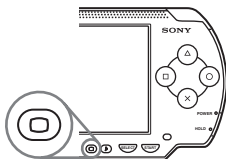

您每按一次此按鈕，都能依照下列順序變更畫面的顯示方式：

第一級	較暗 ↓ 較亮
第二級	
第三級	
(第四級)	

#### 提示

只有在使用交流電轉換器時才可選擇第四級。

## 關閉背光燈

### 1 按住顯示按鈕一秒鐘以上。

背光燈將關閉且畫面會變成一片烏黑。

只要再按下主機的任何一個按鈕，畫面即會再度顯示。

# 電池

## 電池殘存充電量

電池殘存充電量會顯示在畫面上。

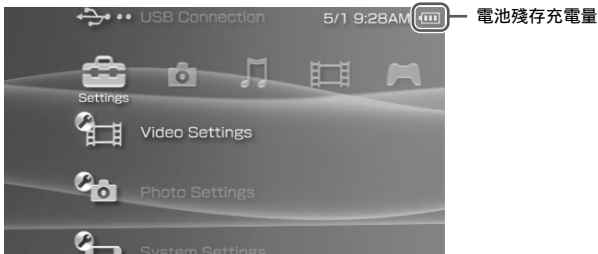

## 殘存電力的預估標準

	剩餘電力充足。
	電力不足。
	電力即將耗盡。
	電力已耗盡。POWER（電源）指示燈閃爍綠色。請替電池充電。

### 提示

- 若 POWER（電源）指示燈閃爍綠色，請保存遊戲進度並替電池充電。若電池的電力於保存前即已耗盡，則會喪失尚未保存的資料。
- 顯示的充電量會因使用狀況與溫度等環境因素，而與實際的充電量有些微差異。若顯示不正確，請繼續使用電池組直到電力完全耗盡並再次充電。請注意，於遭遇下列情況時，充電量可能無法精確顯示：
  - 長時間在高溫狀態下使用電池
  - 電池在充電後很久沒有使用
  - 電池已經充電太多次
- 您也可選擇 "System Settings（系統設定）"（▶▶ 第 223 頁）的 "Battery Information（電池資訊）"，以確認電池的殘存充電量。

- 若於電池電力耗盡後並未再次使用 PSP™ 主機，則日期與時間的設定可能會被重新設定。於發生此類情形時，主機會於再度啟動時，顯示日期與時間的設定畫面。
- 使用 WLAN 功能時將無法替電池充電。

## 電池的預估持續時間

遊戲	約 3 - 6 小時 *1
播放影像	約 3 - 5 小時 *2

\*1 選擇單人遊玩模式，使用線控裝置與耳機，但未使用無線 LAN，選用附屬電池組的測試結果。

\*2 選擇交替使用主機喇叭、耳機，且切換各種音量與畫面亮度的測試結果。

### 提示

電池使用時間會視遊戲內容與使用狀況，例如畫面亮度與環境因素，而有所不同。隨著電池使用時間越久，電池使用時間也會逐漸縮短。

## 電池的預估充電時間

若使用附屬電池組，於耗盡電池電力後使用交流電轉換器，大約需充電 2 小時 20 分始可充電完畢。

### 提示

- 請在 10° C 至 30° C / 50° F 至 86° F 的溫度間為電池充電。在其他溫度間的充電動作可能無效。
- 充電時若打開主機電源可能會延長充電時間。

## 電池組壽命

電池組的壽命有限。電池續航力（使用時間）會因重複使用的次數與時間而不斷減少。若電池續航力變得極度短暫，就代表可能必須更換電池組。

### 提示

電池組的壽命會依其放置狀態、使用情形以及溫度等環境因素而有所不同。

## 更換電池組

爲了安全起見，請在更換電池組之前先關閉主機電源並自電池插座拔下交流電轉換器。亦請在處理電池組之前先參閱 " 電池組注意事項 " (●▶第 148 頁)。

### 提示

若於取出電池組後並未再度使用 PSP™ 主機，則日期與時間的設定可能會被重新設定。於發生此類情形時，主機會於再度啟動時，顯示日期與時間的設定畫面。

## 保存電池組

若長時間不使用 PSP™ 主機，請從主機中取出電池組並放置在陰涼、乾燥且兒童拿不到的地方保管。

## 玩遊戲



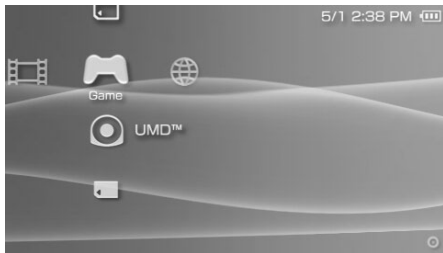





- 1 選擇自家選單的 。
- 2 插入 UMD™ (▶第 164 頁)。  
顯示 UMD™ 圖示。







- 3 選擇遊戲圖示後，按下  按鈕。  
開始遊戲。

## Game（遊戲）時顯示的圖示

除了玩遊戲之外，Game（遊戲）尚能執行下列功能。

	Game Sharing（遊戲分享）	您可使用 Ad Hoc 模式 (  ▶第 235 頁)，接收另一台 PSP™ 的遊戲資料。詳細說明，請參閱該遊戲軟件附帶的使用說明書。
	Saved Data Utility（管理保存資料）	您可拷貝、刪除或檢視存入 Memory Stick Duo™ (  ▶第 176 頁) 之保存資料的相關資訊。
	UMD™	您可遊玩遊戲。於您選擇 UMD™ 後，即會顯示該遊戲的簡介。
	PSP™ Update（PSP™ 更新）	您可替 PSP™ 主機更新系統軟件。唯有當 UMD™ 內含有更新資料時，始會顯示此圖示 (  ▶第 247 頁)。
	Memory Stick™	你可利用更新，存取被保存於 Memory Stick Duo™ (  ▶第 247 頁) 的更新資料。

## 提示

- 若您選擇  (UMD™) 圖示時，顯示了  (Restricted Content: 限制內容) 圖示，即代表其具有限制內容功能。您必須依照以下手續輸入密碼，才能遊玩該遊戲。詳細請參閱 "Parental Control Level: 視聽年齡限制" (▶▶ 第 231 頁)。
  - 1 選擇  (Restricted Content: 限制內容) 後，按下  按鈕。
  - 2 使用方向按鈕輸入四位數的密碼後，按下  按鈕。
- 若於遊玩途中按下 HOME (歸返) 按鈕，可檢查目前的殘存電力。
- 本說明書中刊載的遊戲名稱與簡介圖像皆非實際產品。

## 離開遊戲

- 1 請於遊玩途中按下 HOME (歸返) 按鈕。  
顯示 "Do you want to quit the game? (您要離開遊戲嗎?)" 的訊息。
- 2 選擇 "Yes (是)" 後，按下  按鈕。  
結束遊戲並顯示自家選單。

# 遊戲選項選單

於顯示選項選單後，您可檢視遊戲資訊或拷貝、刪除保存資料。

## 1 選擇圖示後，按下△按鈕。

顯示選項選單。



圖示

選項選單

## 2 選擇選單項目後，按下○按鈕。

### 關閉選項選單

按下△按鈕或×按鈕。

### 操作一覽表

有效的選單項目會因選擇之圖示而有所不同。





Start (開始)	開始遊玩或下載資料
Copy (拷貝)	將 Memory Stick Duo™ 內的保存資料拷貝至另一張 Memory Stick Duo™ (▶▶ 第 176 頁)
Delete (刪除)	刪除 Memory Stick Duo™ 內的資料
Information (資訊)	顯示所選圖示的相關資訊

## 拷貝及刪除保存資料

利用「管理保存資料」功能，您可拷貝或刪除保存於 Memory Stick Duo™ 內的遊戲保存資料。

### 拷貝保存資料

您可將保存資料拷貝至另一張 Memory Stick Duo™。建議您應為重要的資料預留備份檔案。

- 1 選擇  後，按下  按鈕。
- 2 選擇您想要拷貝的保存資料後，按下  按鈕。  
顯示選項選單。
- 3 選擇 "Copy (拷貝)" 後，按下  按鈕。
- 4 遵循畫面指示進行操作。

### 若可用空間不足

請刪除設為保存位置之 Memory Stick Duo™ 內的資料，或是更換其他的 Memory Stick Duo™。於開啟選項選單 (►► 第 175 頁) 後，您可刪除保存資料或檢查剩餘的可用空間。

#### 提示

隨使用之 Memory Stick Duo™ 種類的不同，儘管是相同的資料，亦可能會出現不同的檔案大小顯示。

### 刪除保存資料

您可於 "拷貝保存資料" 的步驟 3，選擇 "Delete (刪除)"，以刪除 Memory Stick Duo™ 內的保存資料。





## 觀賞影像



您可觀賞 UMD™VIDEO 或保存於 Memory Stick Duo™ 內的影像。

- 1 選擇自家選單的 。
- 2 插入 UMD™ 或 Memory Stick Duo™ (→▶第 164、165 頁)。顯示被插入之媒體的圖示。







- 3 選擇圖示後，按下  按鈕。  
開始播放 UMD™VIDEO。若您選擇 ，將會顯示每個影像資料的圖示。選擇您想要播放的影像後，按下  按鈕。

## Video (影像) 時顯示的圖示

	UMD™	您可播放 UMD™VIDEO。於您選擇此圖示後，即會顯示該影像的簡介。
	Memory Stick™	您可播放保存於 Memory Stick Duo™ 內的影像。

### 提示

- 若您選擇  (UMD™) 圖示時，顯示了  (Restricted Content: 限制內容) 圖示，即代表其具有限制內容功能。您必須依照以下手續輸入密碼，才能觀賞該影片。詳細請參閱 "Parental Control Level: 視聽年齡限制" (●▶第 231 頁)。
  - 1 選擇  (Restricted Content: 限制內容) 後，按下  按鈕。
  - 2 使用方向按鈕輸入四位數的密碼後，按下  按鈕。
- 若於影像播放途中按下 HOME (歸返) 按鈕或是 SELECT (選擇) 按鈕，螢幕上將會顯示自家選單以及目前播放之影像的暫停靜止畫面。只要您再按下任何一個按鈕，即可關閉自家選單。
- 您可使用聲音按鈕 (●▶第 167 頁) 來調整音質或選擇靜音。
- 關於 PSP™ 主機可播放之檔案格式，請參閱 "可播放的檔案" (●▶第 251 頁)。

## 停止播放

- 1 於播放影像時，按下  按鈕。  
停止播放。

### 提示

通常，於您下次再度選擇播放時，都會從停播點起繼續播放。

## 從頭開始播放影像

若您想從頭開始播放 UMD™VIDEO，請於選擇選項選單 (●▶第 187 頁) 的 "Play from Beginning (從頭開始播放)" 後，按下  按鈕。

# 使用控制介面

您可使用螢幕上的控制介面，執行下列操作。

## 重要

某些 UMD™VIDEO 會因為軟件製作者的意圖，而被事先設定播放條件。當遭遇這類情形時，即使您依照本說明書的指示進行操作，亦可能會出現無法啟動之現象。

- 1 於播放影像時，按下  $\triangle$  按鈕。  
顯示控制介面。



- 2 選擇圖示後，按下  $\odot$  按鈕。

## 隱藏控制介面

按下  $\triangle$  按鈕或  $\times$  按鈕。

## 操作一覽表

播放 UMD™VIDEO 時顯示的圖示與播放保存於 Memory Stick Duo™ 之影像時顯示的圖示並不相同。



圖示	說明
 Menu (選單)	顯示 UMD™VIDEO 選單
 Go To (進入)	自指定的章或時間起開始播放 (●▶第 182 頁)

圖示	說明
 Audio Options (聲音選項)	切換選擇錄製了多種音軌之 UMD™VIDEO 的播放語言 替保存於 Memory Stick Duo™ 的影像，滑動更換輸入方式 (左、右、或左+右)。
 Angle Options (角度選項)	切換選擇錄製了多角度之 UMD™VIDEO 的播放角度
 Subtitle Options (字幕選項)	切換選擇錄製了多種字幕之 UMD™VIDEO 的顯示字幕
 UMD™Video Volume (UMD™Video 音量)	改變 UMD™VIDEO 的音量 (**▶第 183 頁)
 Screen Mode (螢幕模式)	變更螢幕的顯示比例 (**▶第 182 頁)
 Display (顯示)	顯示播放狀態與相關資訊 (**▶第 181 頁)
 Help (輔助)	顯示使用 PSP™主機之按鈕可執行的功能
 Previous (後退)	播放 UMD™VIDEO 時，返回上一個章節的開頭 Return to Beginning (回到開頭)
 Next (前進)	跳至下一個章節*
 Fast Reverse/ Fast Forward (快退 / 快進)	快退 / 快進播放畫面，以幫助您尋找特定場景 (**▶第 183 頁)
 Slow Motion (慢動作)	慢動作播放場景 (**▶第 184 頁)
 Frame Advance (停格播放)	以格為單位的播放
 Play (播放)	開始播放

圖示		說明
	Pause (暫停)	暫停播放
■	Stop (停止)	停止播放
A-B	A-B Repeat (A-B 重複)	重複播放特定的部分 (•▶ 第 185 頁)。
↻	Repeat (重複)	重複播放影像 (•▶ 第 184 頁)
CLEAR	Clear (解除)	解除 "Repeat (重複)" 設定

\* 播放保存於 Memory Stick Duo™ 之影像時，無法執行此項操作。

## 檢視播放狀態與相關資訊

- 於播放時，選擇控制介面的  後，按下  按鈕。  
顯示該影像的播放狀態。



## 隱藏顯示

選擇控制介面的  後，按下  按鈕。

## 提示

播放 UMD™VIDEO 時顯示的項目與播放保存於 Memory Stick Duo™ 之影像時顯示的項目並不相同。

## 變更 Screen Mode (螢幕模式)

變更螢幕的顯示比例。

### 1 選擇控制介面的 後，按下 按鈕。

您每按一次  按鈕，都能依照下列順序變更 Screen Mode (畫面模式)：

Normal (標準)	配合 PSP™ 的螢幕尺寸調整影像
Zoom (放大)	不改變縱橫比，切除上下或左右的邊緣畫面，以全畫面顯示
Full Screen (全景)	改變縱橫比，上下左右伸縮畫面，以全畫面顯示
Original (原始)	以原始比例顯示影像
4:3	以 4:3 的方式顯示以 16:9 方式錄製的影像

## 提示

部分影像可能無法改變螢幕模式的顯示比例。

## 從選擇的場景開始播放

您可從指定的章或時間起開始播放。

### 1 選擇控制介面的 後，按下 按鈕。

### 2 使用方向按鈕，指定章或時間後，按下 按鈕。

Chapter (章)	指定章節碼 *
XX:XX:XX	指定經過時間

\* 當播放保存於 Memory Stick Duo™ 的影像時，您無法使用此功能。

## 調整 UMD™Video 的音量

如果 UMD™ 的輸出音量較低，則您可以調整音量。

### 1 選擇控制介面的 後，按下 按鈕。

您每按一次  按鈕，都能依照下列順序變更音量：

+1	提高音量
+2	提高音量 (最大)
Normal (標準)	通常選擇此項設定

#### 提示

音量設定會於取出 UMD™ 後自動解除。若想維持高音量設定，請選擇 "Video Settings (影像設定)" ( 第 220 頁)。



## Fast Reverse/Fast Forward (快退 / 快進)

### 1 於播放時，選擇控制介面的 或 後，按下 按鈕。



### 返回正常播放

選擇控制介面的  後，按下  按鈕。

#### 提示

使用 Fast Reverse (快退) 或 Fast Forward (快進) 時，可選擇控制介面的  或 ，並按下  按鈕，以 3 階段調整播放速度。

## 慢放

1 於播放時，選擇控制介面的  後，按下  按鈕。

## 返回正常播放



選擇控制介面的  後，按下  按鈕。

### 提示

暫停播放時，選擇控制介面的  或  後，按下  按鈕，即可開始慢放。若選擇  (Fast Forward: 快進)，則只會於按住  按鈕時進行慢放。

## 重複播放

可反覆持續播放整張光碟或某個章。

1 選擇控制介面的  後，按下  按鈕。  
您每按一次  按鈕，都能依照下列順序變更重複模式：

Disc Repeat (光碟重複播放)	重複播放整張光碟
Chapter Repeat (章重複播放)	重複播放指定的章
Repeat Off (解除重複播放)	結束重複播放



### 提示

- 您亦可於選擇控制介面的 **CLEAR** 後按下  按鈕，以停止重複播放。
- 播放保存於 Memory Stick Duo™ 的影像時，只能選擇 "Repeat On (開始重複播放)" 或 "Repeat Off (解除重複播放)" 兩種重複選項。



## 重複播放影像的特定部份 A-B

您可指定希望重複播放的部分後開始播放。

- 1** 於播放時，選擇控制介面的 A-B，並於希望重複播放之部分的起點，按下  按鈕。  
起點（A 點）設定完成。
- 2** 於希望重複播放之部分的終點，按下  按鈕。  
終點（B 點）設定完成。且開始重複播放指定部分。

### 解除 A-B 重複

選擇控制介面的 A-B 或 **CLEAR** 後，按下  按鈕。

## 利用 PSP™ 主機按鈕或線控裝置進行操作

您也可不使用控制介面，而利用主機的按鈕或線控裝置來操作 PSP™ 主機。

	主機按鈕操作	線控裝置操作
播放	按  按鈕或 START (開始) 按鈕	按  按鈕
暫停	按 START (開始) 按鈕	按  按鈕
顯示 UMD™VIDEO 選單	按  按鈕 *1	-
停止	按  按鈕	-
播放上一章	按 L 按鈕 *1	按  按鈕 *1
播放下一章	按 R 按鈕 *1	按  按鈕 *1
快退	按方向按鈕左 *2	按下並按住  按鈕
快進	按方向按鈕右 *2	按下並按住  按鈕
慢放	暫停時按方向按鈕右 *2	暫停時，按下並按住  按鈕

\*1 播放保存於 Memory Stick Duo™ 的影像時，將無法執行此項操作。

\*2 若您按下並按住此按鈕，則將會持續以 Fast Reverse (快退) /Fast Forward (快進) /Slow (慢放) 的方式播放影像。

### 提示

當畫面上顯示控制介面時，將無法操作某些按鈕。遇此情形時，請按下  按鈕以關閉控制介面。

# 影像選項選單

您可使用 Video（影像）選項選單，以播放 UMD™VIDEO、檢視相關資訊，或是刪除保存於 Memory Stick Duo™ 的影像。

- 1 選擇圖示後，按下  $\Delta$  按鈕。  
顯示選項選單。



- 2 選擇選單項目後，按下  $\odot$  按鈕。

## 關閉選項選單

按下  $\Delta$  按鈕或  $\times$  按鈕。

## 選項一覽表

有效的選單項目會因選擇之圖示而有所不同。

Play（播放）	播放 UMD™VIDEO 或保存於 Memory Stick Duo™ 的影像
Play from Beginning （從頭開始播放）	從頭開始播放 UMD™VIDEO
Delete（刪除）	刪除保存於 Memory Stick Duo™ 的影像
Information（資訊）	顯示所選圖示的相關資訊

## 將影像保存至 Memory Stick Duo™

可使用下列兩種方式將影像保存至 Memory Stick Duo™。

### 相容 Memory Stick™ 規格的裝置錄製的畫像或影像

當您準備了影像格式為 PSP™ 主機可播放格式之裝置時，您可透過該裝置，在 PSP™ 主機上，播放插入 Memory Stick Duo™ 內的影像。

\* 若您想了解 PSP™ 主機可播放之影像檔案類型的相關資訊，請參閱 "可播放的檔案" (▶▶ 第 251 頁)。若您想了解更多關於對應機器的資訊，請連結以下網站 (<http://www.memorystick.com/psp>)。

#### 提示

若您的機器只能使用標準尺寸的 Memory Stick™ 時，您必須準備 Memory Stick Duo 專用轉接卡 (型號: MSAC-M2。需另行選購之 Sony 產品)。

## 將影像檔案從電腦傳送至 Memory Stick Duo™

您可將利用另一部裝置拍攝或錄製的影像轉換成 PSP™ 主機的可相容格式，並使用相容軟件傳送至 Memory Stick Duo™\*。

\* 詳情請瀏覽 <http://www.memorystick.com/psp>。

可透過下列方式傳送檔案：

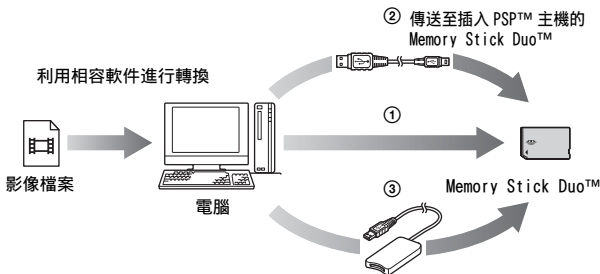

- ① 使用有 Memory Stick™ 插口的電腦。\*
- ② 使用市售的 USB 連接線（●▶第 233 頁）。
- ③ 使用市售的 Memory Stick USB 讀卡機。\*

\* 若您的裝置只能使用標準尺寸的 Memory Stick™ 時，您必須準備 Memory Stick Duo 專用轉接卡（型號：MSAC-M2。需另行選購之 Sony 產品）。

### 提示



- 若欲了解更多規格的相關資訊，請瀏覽以下網站（<http://www.memorystick.com/psp>）。
- PSP™ 無法播放以高於 768kbps 的位元率轉換的影像資料。
- 您必須將中文的檔案名稱修改為英文或數字。PSP™ 主機無法正確顯示中文的檔案名稱。

## 聽音樂

您可聆聽 UMD™MUSIC 與保存於 Memory Stick Duo™ 的音樂。

- 1 選擇自家選單的 。
- 2 插入 UMD™ 或 Memory Stick Duo™ (→ 第 164、165 頁)。  
顯示被插入之媒體的圖示。





- 3 選擇圖示後，按下  按鈕。  
開始播放。於顯示群組或曲目時，選擇您想聽的曲目後，按下  按鈕。

## 提示

內含影像內容 (例如音樂 MTV) 之 UMD™MUSIC 能以播放 UMD™VIDEO 時的相同方法開始播放。詳情請參閱 "影像" 的 "使用控制介面" (→ 第 179 頁)。

## Music (音樂) 時顯示的圖示

 UMD™	您可播放 UMD™MUSIC。於您選擇此圖示後，即會顯示該音樂的簡介。
 Memory Stick™	您可播放保存於 Memory Stick Duo™ 內的音樂。

## 提示

- 您可於步驟 3 時，按下線控裝置的 START (開始) 按鈕或是 ►|| 按鈕，開始播放第一個群組之第一首曲目。
- 若於播放途中按下 HOME (歸返) 按鈕或是 SELECT (選擇) 按鈕，將強制返回自家選單。只要再按下任何一個按鈕，即可開啟音樂播放畫面。
- 您可使用聲音按鈕 (◄► 第 167 頁) 來調整音質或選擇靜音。
- 關於 PSP™ 主機可播放之檔案格式，請參閱 "可播放的檔案" (◄► 第 251 頁)。
- 本說明書中刊載的遊戲名稱與簡介圖像皆非實際產品。

## 何謂 Group (群組) ?

Group (群組) 為依照歌曲或演唱 / 演奏者等特定順序整理的音樂資料庫。當開啟 Group Mode (群組模式) 時，PSP™ 主機可依據使用電腦編輯的群組進行播放。

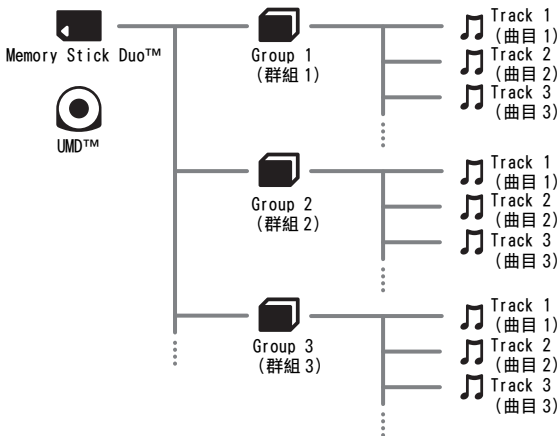

## 提示

- 您無法使用 PSP™ 建立或編輯群組。
- 一首 "Track (曲目; 音軌)" 代表一首歌曲。
- 音樂影片等，UMD™MUSIC 的收錄內容，並不支援群組功能。

## 停止播放

- 1 於播放音樂時，按下 ⊗ 按鈕。  
停止播放。

## 如何觀看畫面

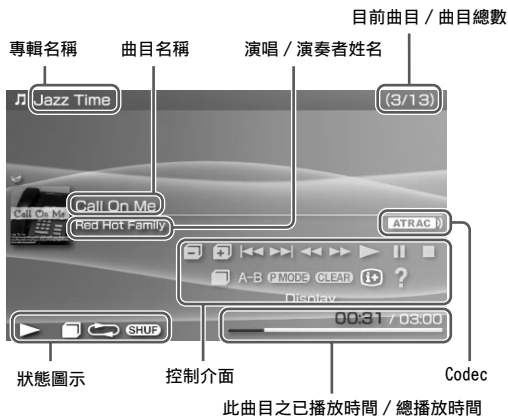

### 提示

- "專輯名稱"與"目前曲目 / 曲目總數"唯有於開啟 (i+) (顯示) 功能時才會顯示於畫面中。
- 顯示於 "狀態圖示" 欄位的圖示會因選擇之播放模式而有所不同。
- Codec 的詳細說明，請參閱 "選擇 codec 進行播放" (▶▶ 第 199 頁)。



# 使用控制介面

您可使用螢幕上的控制介面，執行下列操作。

- 1 於播放時，按下  $\triangle$  按鈕。  
顯示控制介面。

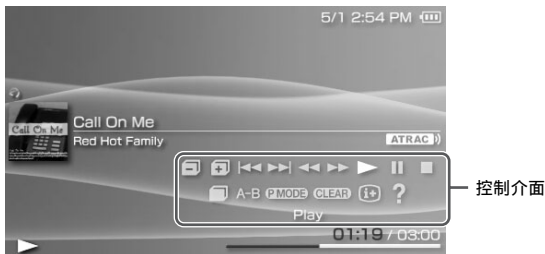

- 2 選擇圖示後，按下  $\odot$  按鈕。

## 提示

內含影像內容（例如音樂 MTV）之 UMD™MUSIC 能以播放 UMD™VIDEO 時的相同方法開始播放。詳情請參閱“影像”的“使用控制介面”（▶▶第 179 頁）。

## 隱藏控制介面

按下  $\triangle$  按鈕或  $\otimes$  按鈕。

## 操作一覽表



圖示	說明
 Previous Group (上一個群組)	返回上一個群組的開頭
 Next Group (下一個群組)	跳至下一個群組的開頭
 Previous Track (上一首曲目)	返回播放中曲目的開頭或上一首曲目的開頭

圖示		說明
	Next Track (下一首曲目)	跳至下一首曲目的開頭
	Fast Reverse/ Fast Forward (快退 / 快進)	快退 / 快進* 播放
	Play (播放)	播放曲目
	Pause (暫停)	暫停播放
	Stop (停止)	停止播放
	Group Mode (群組模式)	切換為 Group Mode (群組模式) (**►第 194 頁)
A-B	A-B Repeat (A-B 重複播放)	指定曲目的某一部分，重複進行播放。 (**►第 195 頁)
	Play Mode (播放模式)	切換為 Play Mode (播放模式) (**►第 195 頁)
	Clear (解除)	解除 Group Mode (群組模式)、Play Mode (播放模式) 與 A-B Repeat (A-B 重複播放) 設定
	Display (顯示)	顯示專輯名稱、目前曲目與曲目總數
	Help (輔助)	顯示主機之按鈕可執行的功能



\* 按住  按鈕，即可持續執行快退 / 快進。



## 使用 Group Mode (群組模式)

以群組方式播放曲目。於播放群組中的所有曲目後便會停止播放。

- 1 於播放時，選擇控制介面的  後，按下  按鈕。  
開啟 Group Mode (群組模式)，畫面上顯示 .

## 解除 Group Mode (群組模式)

開啟 Group Mode (群組模式) 時，選擇控制介面的 ，按下  按鈕。

- 1 於播放時，選擇控制介面的 **P MODE** 後，按下  按鈕。  
您每按一次  按鈕，都能依照下列順序變更功能：

播放模式	說明
 1	重複播放某首曲目
	重複播放所有曲目
<b>SHUF</b>	以任意順序播放所有曲目 *
	以任意順序重複播放所有曲目
無顯示圖示	解除 Play Mode（播放模式）並以正常順序播放至最後一首曲目



\* 若設定了群組，則會以任意順序隨機播放群組內的曲目。但不會改變群組的排列順序。

### 提示

可選擇控制介面的 **CLEAR**，按下  按鈕，以解除 Play Mode（播放模式）。

## 重複播放曲目的某一部份 A-B

指定並播放您想重複播放的部分。

- 1 於播放時，選擇控制介面的 A-B，於您想要開始重複播放的時間點，按下  按鈕。  
完成 A 點的設定。
- 2 於您想要結束重複播放的時間點，按下  按鈕。  
完成 B 點的設定，並開始指定部分的重複播放。

## 解除 A-B 重複播放

選擇控制介面的 **A-B** 或 **CLEAR** 後，按下  按鈕，即可消除指定部分，並恢復正常播放。

### 提示

- 只能於單一曲目中指定 A-B 重複播放的範圍。
- 若並未設定終點（B 點），則曲目的結束點將會被自動設定為終點（B 點）。
- 若於設定 Play Mode（播放模式）時設定 A-B 重複播放，將自動解除 Play Mode（播放模式）。



## 利用 PSP™ 主機的按鈕或線控裝置進行操作

您也可不使用控制介面，而利用主機的按鈕或線控裝置來操作 PSP™ 主機。

	主機按鈕操作	線控裝置操作
播放	按  按鈕或 START（開始）按鈕	按  按鈕
暫停	按 START（開始）按鈕	按  按鈕
停止	按  按鈕	-
返回播放中曲目的開頭或上一首曲目的開頭	按 L 按鈕	按  按鈕。或重複按  按鈕，直到回到您想要的曲目為止
跳至下一首曲目的開頭	按 R 按鈕	按  按鈕
快退	按方向按鈕左 *	按下並按住  按鈕
快進	按方向按鈕右 *	按下並按住  按鈕

\* 若您按下並按住此按鈕，則將會持續以 Fast Reverse（快退）/Fast Forward（快進）的方式播放音樂。

### 提示

- 當畫面上顯示控制介面時，將無法操作某些按鈕。遇此情形時，請按下  按鈕以關閉控制介面。
- 內含影像內容（例如音樂 MTV）之 UMD™MUSIC 能以播放 UMD™VIDEO 時的相同方法開始播放。詳情請參閱 "影像" 的 "使用控制介面"（ 第 179 頁）。

# 音樂選項選單

您可使用 Music（音樂）選項選單，以檢視相關資訊，或是刪除保存於 Memory Stick Duo™ 的音樂資料。

- 1 選擇圖示後，按下  $\Delta$  按鈕。  
顯示選項選單。



- 2 選擇選單項目後，按下  $\odot$  按鈕。

## 關閉選項選單

按下  $\Delta$  按鈕或  $\otimes$  按鈕。

## 選項一覽表

有效的選單項目會因選擇之圖示而有所不同。

Play（播放）	播放 UMD™MUSIC 或保存於 Memory Stick Duo™ 的音樂資料
Play from Beginning （自開頭播放）	自 UMD™MUSIC 的開頭起播放
Select Codec （選擇 Codec）	設定音樂播放的檔案格式或位元率（▶▶ 第 199 頁）

Delete (刪除)	刪除保存於 Memory Stick Duo™ 的音樂資料
Information (資訊)	顯示所選圖示的相關資訊

## 選擇 codec 進行播放

播放以多種檔案格式與位元率錄製的 UMD™MUSIC 時，您可以選擇一些選項後再進行播放。

- 1** 選擇您想聆聽的群組後，按下  $\Delta$  按鈕。
- 2** 選擇 "Select Codec (選擇 Codec)" 後，按下  $\odot$  按鈕。  
顯示檔案格式類型與位元率。以灰色顯示的項目由於非屬本機能播放的類型，因此無法選擇。
- 3** 選擇您想聆聽的格式類型與位元率後，按下  $\odot$  按鈕。
- 4** 按下  $\Delta$  按鈕。  
顯示群組的圖示。
- 5** 選擇群組後，再選擇您想聆聽的曲目，按下  $\odot$  按鈕。  
開始播放。

### 提示

"ATRAC3plus™" 等項目為檔案格式的類型，"256kbps" 等項目則代表位元率。一般而言，位元率愈高，音質愈好。檔案類型的詳細說明，請參閱 "可播放的檔案" (▶▶ 第 251 頁)。

## 將音樂傳送並保存至 Memory Stick Duo™

您可使用 PSP™ 主機播放以下列方式取得的音樂資料：

- 1) 從 CD 輸入的音樂。
- 2) 從音樂下載網站購買的音樂。

關於 1) 的方法，請參閱以下的說明。

關於 2) 的方法，請瀏覽關連網站 (<http://www.memorystick.com/psp>) 的介紹。

### 以 ATRAC3plus™ 格式從音樂 CD 輸入音軌

若要從音樂 CD 輸入音軌，您必須先準備一部個人電腦與支援 ATRAC3plus™ 的軟件\*。

\* 詳情請瀏覽 <http://www.memorystick.com/psp>。

您可透過下列方式將輸入的音軌傳送至 Memory Stick Duo™：

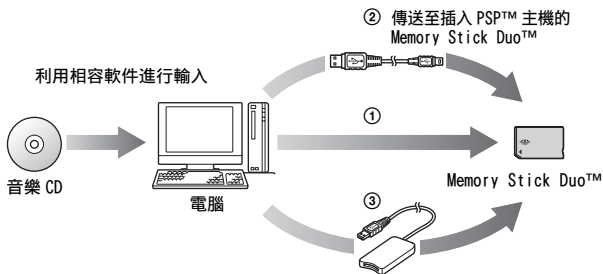

- ① 使用有支援 MagicGate™ 之 Memory Stick™ 插口的電腦。\*1
- ② 使用相容的 USB 連接線 (\*\*▶ 第 233 頁)。\*2
- ③ 使用市售的 Memory Stick USB 讀卡機。\*1\*3

\*1 若裝置上的插口只能使用標準尺寸的 Memory Stick™ 時，您必須準備 Memory Stick Duo 專用轉接卡（型號：MSAC-M2。需另行選購之 Sony 產品）。

\*2 一台已安裝 Windows® XP 且安裝 3.1 或更新版本之 SonicStage™ 的電腦。

\*3 必須準備型號為 MSAC-US30 等，支援 MagicGate™ 的產品（需另行選購之 Sony 產品）。



## 提示

- 若欲了解更多輸入音軌的相關資訊，請瀏覽以下網站 (<http://www.memorystick.com/psp>)。
- 3.2 以前版本的 SonicStage™，無法從 Memory Stick PRO Duo™ 保存或播放 ATRAC3plus™ 的資料。遇此情形，請使用與 MagicGate 相容的 Memory Stick Duo™，避免使用 Memory Stick PRO Duo™ (●▶第 249 頁)。
- PSP™ 主機無法播放有播放時間或播放次數限制的音軌。

## 以 MP3 格式從音樂 CD 輸入音軌

若要從音樂 CD 輸入音軌，您必須先準備一部個人電腦與支援軟件。您可透過下列方式將輸入的音軌傳送至 Memory Stick Duo™：

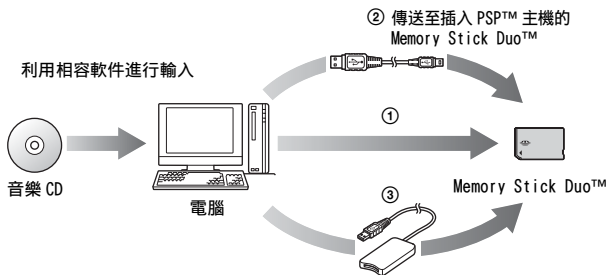

- ① 使用有 Memory Stick™ 插口的電腦。\*
- ② 使用市售的 USB 連接線 (●▶第 233 頁)。
- ③ 使用市售的 Memory Stick USB 讀卡機。\*

\* 若裝置上的插口只能使用標準尺寸的 Memory Stick™ 時，您必須準備 Memory Stick Duo 專用轉接卡 (型號：MSAC-M2。需另行選購之 Sony 產品)。

## 提示

音軌的輸入方法隨軟件而異。詳細請參閱該軟件的使用說明。

## 音樂資料的保存位置

於 Memory Stick Duo™ 直接建立一個名為 "PSP" 的資料夾後，再於 "PSP" 資料夾下建立一個名為 "MUSIC" 的檔案。並將 MUSIC 資料保存於 "MUSIC" 資料夾中。PSP™ 主機無法辨識保存於此資料夾以外的任何資料。

\* 資料夾名稱不需要都是大寫字母。

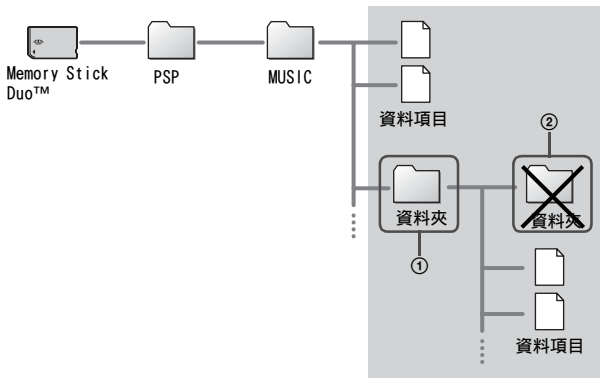

### 提示



- 假如名為 "PSP" 的資料夾已存在於 Memory Stick Duo™ 中，請於該資料夾下建立 "MUSIC" 資料夾。
- 您可於 "MUSIC" 資料夾內新建資料夾（圖 ①），主機將視為一個群組。
- 於子資料夾建立的資料夾將無法被辨識（圖 ②）。
- 假如您想指定音軌的順序，請於資料夾中建立一個 m3u 檔案，以指定順序。主機將會以  (m3u) 圖示顯示該檔案，並視為一個群組。
- 主機無法辨識雖被保存於 "MUSIC" 資料夾，卻非為支援格式的檔案。
- 您必須將中文的檔案名稱修改為英文或數字。PSP™ 主機無法正確顯示中文的檔案名稱。
- 您亦能以使用 MP3 格式檔案時的相同方式輸入或播放 MP4 (AAC) 與 WAV (Linear PCM) 檔案。

## 瀏覽圖像

您可瀏覽、翻閱保存於 Memory Stick Duo™ 內的圖像。

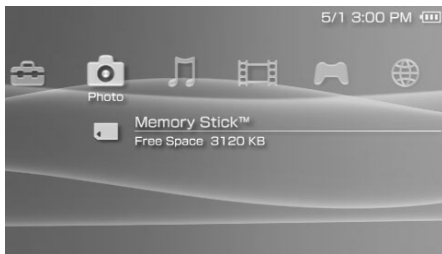
- 1 選擇自家選單的 。
- 2 插入 Memory Stick Duo™ (→ 第 165 頁)。  
顯示 。



- 3 選擇 ，按下  按鈕。  
開始顯示數碼（數位）圖像、資料夾、以及保存於 Memory Stick Duo™ 的靜止圖像。選擇您想要顯示的圖示後，按下  按鈕。

## Photo（相片）時顯示的圖示

 Memory Stick™	您可翻閱保存於 Memory Stick Duo™ 的圖像。
--	--------------------------------

## 提示

- 若於顯示相片時按下 HOME（歸返）按鈕或是 SELECT（選擇）按鈕，螢幕上將會顯示自家選單並繼續顯示圖像。只要您再按下任何一個按鈕，即可返回圖像顯示畫面。
- 關於 PSP™ 主機可播放之檔案格式，請參閱 "可播放的檔案" (→ 第 251 頁)。

# 使用控制介面

您可使用螢幕上的控制介面，執行下列操作。

- 1 於顯示圖像時，按下 $\triangle$ 按鈕。  
顯示控制介面。

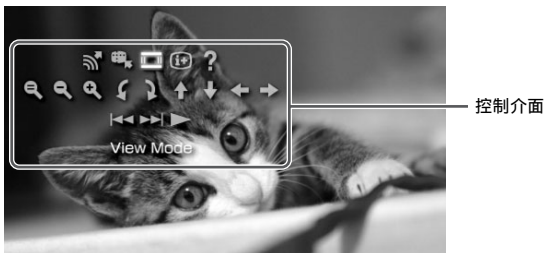









- 2 選擇圖示後，按下 $\odot$ 按鈕。

## 隱藏控制介面



按下 $\triangle$ 按鈕或 $\times$ 按鈕。

## 操作一覽表

圖示		說明
	Send (傳送)	傳送圖像 (●▶第 210 頁)。
	Set as Wallpaper (設定為桌布)	將目前顯示的圖像設定為桌布 (●▶第 207 頁)。
	View Mode (檢視模式)	變更圖像的顯示比例 (●▶第 206 頁)
	Display (顯示)	變更圖像的相關資訊 (●▶第 205 頁)
	Help (輔助)	顯示使用 PSP™ 主機之按鈕可執行的功能

圖示		說明
	Clear Zoom (解除縮放)	讓縮放過的圖像恢復原始比例
	Zoom Out (縮小)	縮小圖像
	Zoom In (放大)	放大圖像
	Rotate Left (左旋轉)	讓圖像朝逆時針方向旋轉 90 度
	Rotate Right (右旋轉)	讓圖像朝順時針方向旋轉 90 度
	Up (上) /Down (下) /Left (左) / Right (右)	當放大圖像或檢視模式設定為放大時，可移動圖像以顯示其他被隱藏的部分。
	Previous (後退)	顯示上一張圖像
	Next (前進)	顯示下一張圖像
	Slideshow (幻燈片秀)	以張為單位，依順序自動顯示圖像 (●▶ 第 211 頁)

## 顯示圖像資訊

- 於顯示圖像時，選擇控制介面的  後，按下  按鈕。  
顯示圖像狀態。



## 隱藏顯示

選擇控制介面的 **i+** 後，按下 **○** 按鈕。

## 調整圖像尺寸

您可變更畫面上的圖像顯示尺寸。

- 於顯示圖像時，選擇控制介面的  後，按下 **○** 按鈕。您每按一次按鈕，都能依照下列順序變更選項：



Normal (標準)	不改變圖像縱橫比，配合螢幕尺寸顯示圖像
Zoom (縮放)	不改變圖像縱橫比，切除上下或左右的邊緣畫面，以全畫面顯示

### 提示

部分圖像可能無法改變 View Mode (檢視模式)。

## 將圖像設定為桌布

您可將目前顯示的圖像設定為桌布。

- 1** 顯示圖像，並選擇控制介面的  後，按下  按鈕。
- 2** 選擇 "Yes (是)" 後，按下  按鈕。  
顯示 "Save completed (保存完成)" 且完成設定。

### 提示

- 您只能替 PSP™ 主機設定一張圖像做為桌布。若您設定且執行了桌布的變更，則已存在之圖像將會覆寫而消滅。
- 若您替圖像進行擴大縮小或迴轉等操作，將會保存已顯示於螢幕上的圖像以為目前的桌布。
- 若您不希望顯示桌布，您可進入 "Theme Settings (主題設定)" 的 "Wallpaper (桌布)" (▶第 225 頁)，變更其設定。

## 利用 PSP™ 主機按鈕或線控裝置進行操作

您也可不使用控制介面，而利用主機的按鈕或線控裝置來操作 PSP™ 主機。

	主機按鈕操作	線控裝置操作
播放幻燈片秀	按 START (開始) 按鈕	按 ►► 按鈕
取消縮放	縮放圖像後按 ⊙ 按鈕	-
Back (返回)	按 ⊗ 按鈕	-
顯示上一張圖像	按 L 按鈕	按 ◀◀ 按鈕
顯示下一張圖像	按 R 按鈕	按 ▶▶ 按鈕
Zoom In (放大)	按住 ⊙ 按鈕並朝上移動類比墊	-
Zoom Out (縮小)	按住 ⊙ 按鈕並朝下移動類比墊	-
旋轉 (左)	按住 ⊙ 按鈕並按下 L 按鈕	-
旋轉 (右)	按住 ⊙ 按鈕並按下 R 按鈕	-
移動 *	移動類比墊	-

\* 於縮放圖像或將 View Mode (檢視模式) 設定為 "Zoom (縮放)" 時，會顯示因縮放機能而隱藏的部分圖像。

### 提示

當畫面上顯示控制介面時，將無法操作某些按鈕。遇此情形時，請按下 ⊕ 按鈕以關閉控制介面。



# 相片選項選單

於顯示 Photo（相片）選項時，您可檢視相關資訊，或是刪除保存於 Memory Stick Duo™ 的圖像。

- 1 選擇圖示後，按下  $\Delta$  按鈕。  
顯示選項選單。



- 2 選擇選單項目後，按下  $\odot$  按鈕。

## 關閉選項選單

按下  $\Delta$  按鈕或  $\times$  按鈕。

## 選項一覽表

有效的選單項目會因選擇之圖示而有所不同。

Slideshow（幻燈片秀）	以張為單位，依順序自動顯示圖像（ $\blacktriangleright$ 第 211 頁）
Receive（接收）	接收圖像（ $\blacktriangleright$ 第 210 頁）。
Display（顯示）	顯示圖像
Send（傳送）	傳送圖像（ $\blacktriangleright$ 第 210 頁）。
Delete（刪除）	刪除資料夾或圖像
Information（資訊）	顯示所選圖示的相關資訊

## 傳送與接收圖像

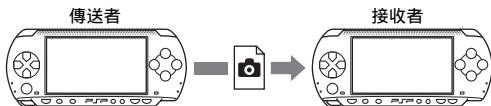

您可透過 Ad Hoc 模式 (●▶第 235 頁)，與另一台 PSP™ 主機傳遞圖像。傳送與接收的執行步驟並不相同。





### 1 設定 Ad Hoc 模式 (傳送者與接收者皆同)

- ① 開啟 PSP™ 主機左側的無線 LAN 按鈕 (●▶第 154 頁)。

### 2 準備接收圖像 (接收者)



- ① 進入 ，選擇您想保存圖像之圖示位置後，按下  按鈕。
- ② 選擇 "Receive (接收)" 後，按下  按鈕。  
主機準備接收圖像。

### 3 傳送圖像 (傳送者)

- ① 選擇您想要傳送的圖像後，按下  按鈕。
- ② 選擇 "Send (傳送)" 後，按下  按鈕。  
顯示準備接收圖像之 PSP™ 主機的暱稱。
- ③ 選擇傳送對象後，按下  按鈕。  
主機開始傳送圖像。

### 4 保存已接收的圖像 (接收者)

圖像的傳遞作業完成後，接收的圖像將會顯示於螢幕中。

- ① 顯示圖像時，按下  按鈕。  
顯示確認資訊。
- ② 選擇 "Yes (是)" 後，按下  按鈕。

#### 提示

- 圖像的保存位置會因您在步驟 2-1 時的選擇而異。請注意您無法將圖像保存於「Digital Camera Images」資料夾。
- 您也可透過螢幕上的控制介面傳遞圖像 (●▶第 204 頁)。

# 播放幻燈片秀

您可設定圖像的顯示順序。

- 1 選擇內含圖像的資料夾或媒體之圖示後，按下 START（開始）按鈕。

開始播放幻燈片秀。顯示的內容會因選擇之圖示而有所不同。

圖示	說明
Memory Stick™	依序顯示保存於 Memory Stick Duo™ 內的所有圖像
Digital Camera Images	依序顯示保存於 "Digital Camera Images" 資料夾內的所有圖像
Folder（資料夾）	依序顯示所選資料夾內的所有圖像
Images（圖像）	依序顯示所選的圖像

CT

顯示

## 停止幻燈片秀

按下 ⊗ 按鈕。

### 提示

- 您可調整圖像的顯示速度。詳細請參閱 "Photo Settings（相片設定）"（●▶ 第 221 頁）。
- 您亦可以下述方法開始幻燈片秀：
  - 從選項選單啟動（●▶ 第 209 頁）
  - 從相片控制介面啟動（●▶ 第 204 頁）

## 使用控制介面

- 1 於播放幻燈片秀時，按下 ⊲ 按鈕。  
顯示控制介面。

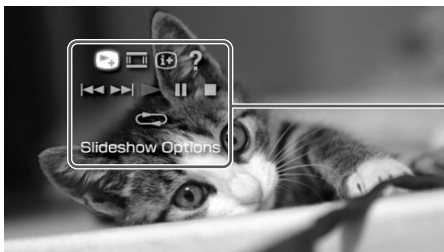

控制介面

**2** 選擇圖示後，按下⓪按鈕。

## 隱藏控制介面



按下⓴按鈕或ⓧ按鈕。

## 作業清單

圖示		說明
	Slideshow Options (幻燈片秀選項)	切換畫面上顯示的資訊 (●▶第 213 頁)
	View Mode (檢視模式)	變更螢幕的圖像顯示比例
	Display (顯示)	顯示圖像的相關資訊
	Help (輔助)	顯示使用 PSP™ 主機之按鈕可執行的功能
	Previous (後退)	顯示上一張圖像
	Next (前進)	顯示下一張圖像
	Play (播放)	開始幻燈片秀
	Pause (暫停)	暫停幻燈片秀
	Stop (停止)	停止幻燈片秀

圖示	說明
 Repeat (重複)	反複播放幻燈片秀

## 顯示幻燈片秀選項

- 於播放幻燈片秀時，選擇控制介面的後，按下按鈕。您每按一次按鈕，都能依照下列順序變更選項：

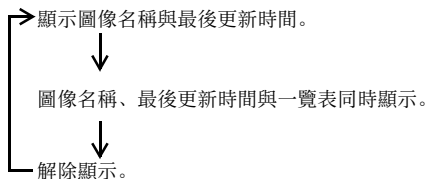

## 利用 PSP™ 主機的按鈕或線控裝置進行操作

您也可不使用控制介面，而利用主機的按鈕或線控裝置來操作 PSP™ 主機。

	主機按鈕操作	線控裝置操作
播放幻燈片秀	按 START (開始) 按鈕	按  按鈕
暫停幻燈片秀	按 START (開始) 按鈕	按  按鈕
停止幻燈片秀	按  按鈕	-
顯示上一張圖像	按 L 按鈕	按  按鈕
顯示下一張圖像	按 R 按鈕	按  按鈕
顯示幻燈片秀選項	按  按鈕	-

### 提示

當畫面上顯示控制介面時，將無法操作某些按鈕。遇此情形時，請按下按鈕以關閉控制介面。

## 將圖像保存至 Memory Stick Duo™

您可透過下列兩種方式保存圖像。

### 使用數位相機拍攝圖像

於使用相容 Memory Stick Duo™ 的數碼（數位）相機時，可將插入相機的 Memory Stick Duo™ 直接插入 PSP™ 主機並愉悅瀏覽。保存於 Memory Stick Duo™ 的圖像將會被顯示於主機的 "Digital Camera Images" 資料夾中。

#### 提示

使用 Memory Stick Duo 專用轉接卡（型號：MSAC-M2。需另行選購之 Sony 產品）後，您即可於僅對應標準尺寸的數碼（數位）相機使用 Memory Stick Duo™。

### 將圖像資料從電腦保存至 Memory Stick Duo™

您可透過下列方式保存圖像：

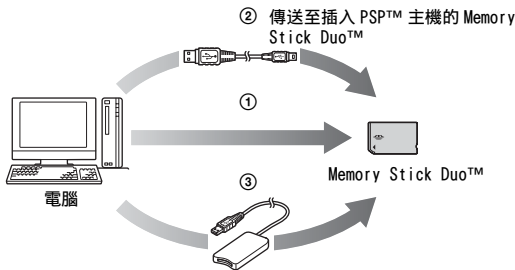

- ① 使用有 Memory Stick™ 插口的電腦。\*
- ② 使用市售的 USB 連接線（\*\*▶ 第 233 頁）。
- ③ 使用市售的 Memory Stick USB 讀卡機。\*

\* 若裝置上的插口只能使用標準尺寸的 Memory Stick™ 時，您必須準備 Memory Stick Duo 專用轉接卡（型號：MSAC-M2。需另行選購之 Sony 產品）。

## 圖像資料的保存位置

於Memory Stick Duo™ 直接建立一個名為 "PSP" 的資料夾後，再於 "PSP" 資料夾下建立一個名為 "PHOTO" 的檔案。並將相片資料保存於 "PHOTO" 資料夾中。PSP™ 主機無法辨識保存於此資料夾以外的任何資料。

\* 資料夾名稱不需要都是大寫字母。

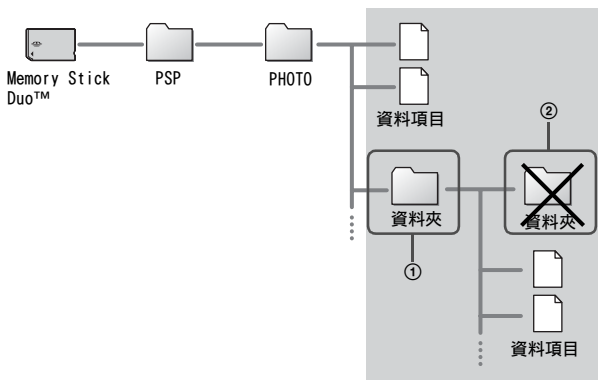

### 提示

- 假如名為 "PSP" 的資料夾已存在於 Memory Stick Duo™ 中，請於該資料夾下建立 "PHOTO" 資料夾。
- 您可於 "PHOTO" 資料夾內新建資料夾（圖 ①）。
- 於子資料夾建立的資料夾將無法被辨識（圖 ②）。
- 本機可能會因圖像資料容量過大而無法顯示部分圖像。
- 曾使用電腦編輯加工的圖像可能無法於 PSP™ 中顯示。
- 您必須將中文的檔案名稱修改為英文或數字。PSP™ 主機無法正確顯示中文的檔案名稱。

## 連接網際網路（互聯網）

您可使用網路瀏覽介面，與網際網路（互聯網）連線並閱覽 WEB 網頁。注意您必須在可連接網路的位置下使用始可連線。

### 1 確認是否已經完成網路設定。

連接網際網路（互聯網）前，必須先輸入 Infrastructure（基礎建設）模式的連線設定（▶▶ 第 235 頁）。

### 2 進入自家選單的 ，選擇 後，按下 按鈕。 啟動網路瀏覽介面，顯示選單。



### 3 使用方向按鈕之上，選擇位址列後按下 按鈕。 螢幕上顯示鍵盤。





- 4** 使用鍵盤 (→ 第 245 頁)，輸入網址。  
輸入結束後即可與網路連線。畫面右下角會於連線時顯示忙碌圖示。連線成功後，即會顯示 Web 網頁。



- 5** 顯示 Web 網頁後，可按下  $\Delta$  按鈕，隱藏選單。  
按下  $\Delta$  按鈕，可要求顯示 / 隱藏選單。進入選單列，您可使用 "Back (返回)"、"Close Page (關閉網頁)" 等各種功能與設定。

#### 提示

- 若於尚未連線時，開啟網路瀏覽介面並選擇要瀏覽 Web 網頁的話，將會自動開始嘗試連接網路。
- 通常情形，於連線至網路後，將會自動選擇最後使用的網路設定。
- 網路瀏覽介面並未正式對應繁體中文。若欲取得最新情報，請瀏覽以下網站。  
<http://www.sceh.com.hk> (香港、東南亞)，<http://www.sceh.com.tw> (台灣)

若您想了解更多網路瀏覽介面之使用方法，請閱覽網路瀏覽介面操作手冊的專屬網頁。

<http://www.playstation.com/manual/psp/>

## 關閉網路瀏覽介面

- 1** 於顯示網路瀏覽介面時，按下  $\otimes$  按鈕。  
結束網路瀏覽介面。

您需對使用網路瀏覽介面閱覽網頁或啟動網路上的資料，以及下載等行為負擔一切責任。除依據各國法律規定不可免責之情形外，Sony Computer Entertainment Inc. 與關係企業，對因閱覽網頁、啟動檔案、下載或執行等行為而對網路瀏覽介面或 PSP™ (PlayStation®Portable) 主機造成異常，或出現保存於 Memory Stick Duo™ 之資料消失 / 毀損等情形，皆不負一切相關責任。

## PSP™ 主機的設定

您可調整 PSP™ 主機的設定以及影像、相片、網路等功能的設定。

- 1 選擇自家選單的 。  
顯示各種設定的圖示。

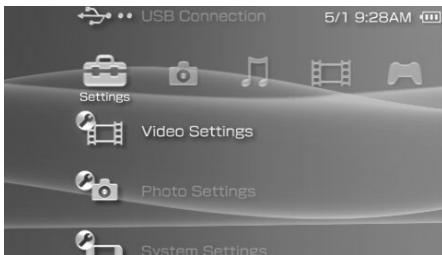

- 2 選擇圖示後，按下  按鈕。  
顯示選擇圖示的設定畫面。詳細請參閱各設定的介紹說明（▶▶ 第 219-244 頁）。

## Settings (設定) 時顯示的圖示

	Network Update (網路更新)	提供主機之系統軟件的更新 (●▶第 242 頁)
	USB Connection (USB 連接)	使用市售的 USB 連接線，可連接電腦 (●▶第 233 頁)
	Video Settings (影像設定)	設定 UMD™VIDEO 的 Menu Language (選單語言)、Audio Language (聲音語言) 與 Subtitle Language (字幕語言)。 (●▶第 220 頁)
	Photo Settings (相片設定)	調整幻燈片秀的播放速度 (●▶第 221 頁)
	System Settings (系統設定)	設定 System Language (系統語言)、Nickname (暱稱)，並能進行 Memory Stick Duo™ 的格式化。(●▶第 222 頁)
	Theme Settings (主題設定)	用戶可自行改變背景顏色或使用圖像做為桌布 (●▶第 225 頁)。
	Date & Time Settings (日期 & 時間設定)	可設定 date and time (日期與時間) 與 daylight saving time (夏令時間) 等。 (●▶第 226 頁)
	Power Save Settings (省電設定)	自動關閉背光燈與進入睡眠模式的設定。 (●▶第 227 頁)
	Sound Settings (聲音設定)	設定 AVLS(Automatic Volume Limiter System; 自動音量限制系統) 與 Key Tone (按鍵音)。(●▶第 229 頁)
	Security Settings (安全性設定)	變更 Parental Control (視聽年齡限制) 的密碼與等級設定。(●▶第 230 頁)
	Network Settings (網路設定)	無線 LAN 的網路連線設定。(●▶第 235 頁)

## Video Settings (影像設定)

您可設定 UMD™VIDEO 的語言或調整 UMD™VIDEO 的音量。

### 重要

某些 UMD™VIDEO 會因為軟件製作者的意圖，而被事先設定播放條件。當遭遇這類情形時，即使您依照本說明書的指示進行操作，亦可能會出現無法啟動之現象。

Menu Language (選單語言)	選擇 UMD™VIDEO 選單的使用語言
Audio Language (聲音語言)	選擇要聽的語言
Subtitle Language (字幕語言)	選擇所需要的字幕
UMD™Video Volume (UMD™Video 音量)	於 UMD™VIDEO 的輸出音量很低時調整音量。音量的調整順序如下: "Normal (標準)"、"+1"、"+2"。

### 提示

購買時的初期預設如下:

- "Menu Language (選單語言)" 與 "Subtitle Language (字幕語言)" 是設定為 "English (英文)" (PSP-1006 K) 或 "Chinese (中文)" (PSP-1007 K)。
- "Audio Language (聲音語言)" 是設定為 "Original Language (原始語言)"。
- "UMD™Video Volume (UMD™Video 音量)" 是設定為 "Normal (標準)"。

您可設定幻燈片秀的播放速度。

Fast (高速)	以較快的速度顯示圖像
<u>Normal</u> (標準)	以標準速度顯示圖像
Slow (慢速)	以較慢的速度顯示圖像

選單項目的初期預設標有下線。

## System Settings (系統設定)

您可調整 PSP™ 主機的系統設定並閱覽相關資訊，或是為 Memory Stick Duo™ 進行格式化。

### Nickname (暱稱)

您可變更於初始設定時選擇的暱稱。請使用畫面上顯示的鍵盤，輸入一個新的暱稱。輸入文字的詳細使用方法，請參閱 " 如何使用鍵盤 " (▶▶ 第 245 頁)。

### System Language (系統語言)

設定自家選單等系統選單的語言。

Deutsch	以德文顯示訊息
<u>English</u>	以英文顯示訊息
Español	以西班牙文顯示訊息
Français	以法文顯示訊息
Italiano	以義大利文顯示訊息
Nederlands	以荷蘭文顯示訊息
Português	以葡萄牙文顯示訊息
Русский	以俄文顯示訊息
日本語	以日文顯示訊息
한국어	以韓文顯示訊息

選單項目的初期預設標有下線。

## Character Set (文字設定)

您可替音樂以及其他類型的檔案設定文字編碼。通常情形並無必要調整此項設定。

For File Names (檔案名稱)	設定音樂以及其他檔案名稱的文字編碼。
For Text in Files (檔案文書)	設定 m3u 文書以及其他類型檔案的文字編碼。

### 提示

初期預設為 "Multilingual Latin 1 (850)"。

## Battery Information (電池資訊)

您可閱覽主機電源的相關資訊。

Charge Level (充電量)	以百分比顯示電池的充電量
Hours Left (剩餘時間) *	顯示電池剩餘的使用時間 (充電時例外)
Power Source (電力來源)	顯示目前電力來源為 "External (外接)" 或 "Battery (電池)"
Battery Status (電池狀態)	顯示電池狀態為 "In Use (使用中)"、"Charging (充電中)" 或 "Charge Complete (充電完成)"

\* 主機預測的時間皆為估計數字，非為正確數值。

### 提示

顯示的充電量會因使用狀況與溫度等環境因素，而與實際的充電量有些微差異。

## Format Memory Stick™ (Memory Stick™ 格式化)

您可使用主機，進行 Memory Stick Duo™ 的格式化。請遵循畫面上的指示，正確操作。

### 重要

於進行格式化後，原先保存於 Memory Stick Duo™ 內的軟件與資料都會遭強制刪除，且永遠無法恢復。請小心不要因意外疏忽而刪除了重要資料。

## Restore Default Settings (恢復預設)

讓所有設定皆回復至購買時的初期設定。請遵循畫面上的指示，正確操作。

### 重要

- 恢復預設後，之前變更的所有設定都會遭強制消滅，且永遠無法恢復。
- 執行更新後，將無法使用系統軟件更新前版本之機能。

## System Information (系統資訊)

您可閱覽 PSP™ 主機的相關資訊。

MAC Address (MAC 位址)	顯示 MAC 位址
System Software (系統軟件)	顯示系統軟件的版本
Nickname (暱稱)	顯示暱稱

## About PSP™ (PlayStation®Portable) (關於 PSP™ (PlayStation®Portable))

顯示與 PSP™ 主機使用之軟件有關的商標與著作權資訊。



## Theme Settings (主題設定)

您可改變 PSP™ 主機螢幕的主題或顯示的桌布圖像。

### Theme (主題)

您可改變螢幕之背景顏色。使用方向按鈕選擇背景顏色後，按下  按鈕即可完成設定。

<u>Original</u> (原始預設)	每月自動變更為原先設定的顏色。
顏色樣本	設定為所選擇之顏色。

選單項目的初期預設標有下線。

### Wallpaper (桌布)

您可要求顯示或隱藏桌布。

<u>Do Not Use</u> (不使用)	設定不顯示桌布。
Use (使用)	透過  (Photo (相片)) 設定圖像為桌布 (▶▶ 第 207 頁)。

選單項目的初期預設標有下線。

# Date & Time Settings

## (日期 & 時間設定)



您可設定 PSPTM 主機的日期與時間、時區與夏令時間。請使用方向按鈕選擇項目，並輸入設定，再按下 按鈕即告設定完成。

Date and Time (日期與時間)	設定年、月、日、時、分與秒 (若使用 12 小時制，則請設定 AM/PM)
Date Format (日期顯示方式)	設定年、月和日的螢幕顯示方式
Time Format (時間顯示方式)	設定使用 12 小時制或 24 小時制
Time Zone (時區)	設定適當的時區
Daylight Saving (夏令時間)	選擇 "Standard (標準)" 或 "Daylight Saving (夏令時間)" (初期預設為「Standard (標準)」)

### 提示

- 於變更 Time Zone (時區) 後，日期與時間的設定亦會依據舊時區與新時區之間的差異，自動進行調整。
- 若 "Theme (主題)" ( 第 225 頁) 設定為 "Original (原始預設)"，將會於變更了 "Date & Time Settings (日期 & 時間設定)" 的月份設定後，自動改變背景顏色。

## Power Save Settings (省電設定)

您可透過自動關閉背光燈或進入睡眠模式等方法，節省 PSP™ 主機的消耗電力。

### Backlight Auto-Off (自動關閉背光燈)

於一定時間沒有操作後，主機會自動關閉液晶畫面的背光燈以節省電力。背光燈被關閉後，畫面將顯得晦暗。

Off (關)	背光不會自動關閉。
2 minutes (2 分鐘)	1 分鐘之後讓畫面變暗，再過 1 分鐘之後則關閉背光。
5 minutes (5 分鐘)	1 分鐘之後讓畫面變暗，再過 4 分鐘之後則關閉背光。
10 minutes (10 分鐘)	1 分鐘之後讓畫面變暗，再過 9 分鐘之後則關閉背光。

選單項目的初期預設標有下線。

### 開啟背光燈

背光燈自動關閉後，只要再按下主機的任何一個按鈕，即會立即再度開啟。

#### 提示

於進行以下操作時，Backlight Auto-Off (自動關閉背光燈) 功能可能會暫時失效：

- 播放影像時
- 播放幻燈片秀時

CT

設定

## Auto Sleep (自動睡眠)

您可設定主機於一定時間沒有操作後，即自動進入睡眠模式以節省電力。若您想了解解除睡眠模式的相關資訊，請參閱 "解除睡眠模式" (►►第 163 頁)。

Off (關)	系統不會自動進入睡眠模式。
5 minutes (5 分鐘)	5 分鐘之後進入睡眠模式
10 minutes (10 分鐘)	10 分鐘之後進入睡眠模式
15 minutes (15 分鐘)	15 分鐘之後進入睡眠模式

選單項目的初期預設標有下線。

### 提示

於進行以下操作時，Auto Sleep (自動睡眠) 功能可能會暫時失效：

- 連接交流電轉換器時
- 玩遊戲時
- 播放影像時
- 播放音樂時
- 播放幻燈片秀時

## WLAN Power Save (無線區域網路省電模式)

您可更換無線網路功能的電源模式。若您選擇 "On (開)"，主機將會減少電池消耗量進行通訊。

<u>Off</u> (關)	以最大電力進行通訊
On (開)	以省電模式進行通訊

選單項目的初期預設標有下線。

### 重要

若您設定為 "On (開)"，主機可能無法以充足的電力進行通訊。若遇此情形，請將設定更改為 "Off (關)"。

## Sound Settings (聲音設定)

您可關閉按鍵音並限制音量。

### AVLS (Automatic Volume Limiter System: 自動音量限制系統)

您可設定最大音量，如此能避免聲音自耳機漏出，且降低您在戴上耳機時，因聽不見周圍聲音而遭遇危險的機率。

<u>Off</u> (關)	不設定任何限制；允許手動調整音量
<u>On</u> (開)	設定音量限制

選單項目的初期預設標有下線。

### Key Tone (按鍵音)

您可關閉按鍵音（您按下按鈕時的確認聲音）。

<u>Off</u> (關)	不要製造確認聲音
<u>On</u> (開)	製造確認聲音

選單項目的初期預設標有下線。

CT

設定

## Security Settings (安全性設定)









您可調整 PSP™ 主機安全性功能的相關設定。

### Change Password (變更密碼)

變更四位數的密碼。於進行以下操作時，您需要輸入這個密碼。

- 變更 "Parental Control Level (視聽年齡限制)" 或 "Internet Browser Start Control (網路瀏覽介面控制台)" 的設定。
- 播放內具 "Parental Control Level (視聽年齡限制)" 的 UMD™。
- 當 "Internet Browser Start Control (網路瀏覽介面控制台)" 設定為 "On (開)"，卻要開啟瀏覽介面時。
- 欲變更密碼時。

### 變更密碼

- 1** 進入自家選單的 ，選擇  (Security Settings: 安全性設定) 後，按下  按鈕。
- 2** 選擇 "Change Password (變更密碼)" 後，按下  按鈕。  
顯示密碼輸入畫面。
- 3** 使用方向按鈕，輸入目前的四位數密碼後，按下  按鈕。  
購買後第一次變更密碼時，您必須輸入 "0000"。
- 4** 使用方向按鈕，輸入新的四位數密碼後，按下  按鈕。
- 5** 選擇 "Yes (是)" 後，按下  按鈕。  
密碼完成變更。

#### 提示

請記下您的密碼供未來參考。

## Parental Control Level (視聽年齡限制)

某些 UMD™ 軟件會因為內容需要，而被事先設定視聽年齡限制。您可設定主機的視聽年齡限制，以禁止主機播放一些等級高於主機設定的 UMD™。

## Parental Control Level (視聽年齡限制)

您可關閉主機的視聽年齡限制或自 11 種等級中，挑選適切的等級完成設定。

Off (關)	關閉視聽年齡限制
11-1	設定視聽年齡限制。"1" 為最嚴格，"11" 則最為寬鬆緩和。

選單項目的初期設定為 "9"。

PSP™ 主機與 UMD™ 兩者之視聽年齡限制的結合將決定是否可播放該張 UMD™。兩者造成的組合請參閱下表。

範例：若主機的視聽年齡限制為 "9"，則等級設定為 "1" 至 "9" 的 UMD™ 即可於主機上播放。

		UMD™的視聽年齡限制											
		1	2	3	4	5	6	7	8	9	10	11	
主機的視聽年齡限制	11	■	■	■	■	■	■	■	■	■	■	■	■
	10	■	■	■	■	■	■	■	■	■	■	■	■
	9	■	■	■	■	■	■	■	■	■	■	■	■
	8	■	■	■	■	■	■	■	■	■	■	■	■
	7	■	■	■	■	■	■	■	■	■	■	■	■
	6	■	■	■	■	■	■	■	■	■	■	■	■
	5	■	■	■	■	■	■	■	■	■	■	■	■
	4	■	■	■	■	■	■	■	■	■	■	■	■
	3	■	■	■	■	■	■	■	■	■	■	■	■
	2	■	■	■	■	■	■	■	■	■	■	■	■
	1	■	■	■	■	■	■	■	■	■	■	■	■

■ :可觀賞的UMD™

■ :無法觀賞的UMD™

CT

設定

## 遊戲的視聽年齡限制

若欲了解遊戲分級的相關資訊，請聯絡保證書上記載的 PSP™ 消費者服務中心，以取得必要協助。

### 提示

- 您可進入 UMD™ 選項選單的 "Information (資訊)"，確定該張 UMD™ 的視聽年齡限制。若該張 UMD™ 並未設定視聽年齡限制，則 "Information (資訊)" 的 "Parental Control (視聽年齡限制)" 會顯示 " - "。
- 受視聽年齡限制的 UMD™ 會顯示  (Restricted Content: 限制內容) 圖示。

## Internet Browser Start Control (網路瀏覽介面控制台)

您可限制網路瀏覽介面的使用。

<u>Off</u> (關)	允許開啟網路瀏覽介面。
On (開)	於開啟網路瀏覽介面前，務必先輸入密碼。

選單項目的初期預設標有下線。



## USB Connection (USB 連接)

您可使用市售的 USB 連接線將檔案從電腦傳送至 PSP™ 主機的 Memory Stick Duo™。但能播放的檔案仍限於主機可支援的檔案格式。

### PSP™ 主機可使用的 USB 連接線

需使用對應 Mini-B 5pin (迷你 B 5pin) 類型連接端的 USB 連接線來連接主機。

#### 提示

您可連接安裝 Windows® XP 或 Mac OS X 等平台，支援 USB 大容量資料庫的電腦。

CT

設定

### 使用 USB 連接線連接主機與電腦

您不須關閉電源，即可使用 USB 連接線連接主機與電腦。

#### 1 用 USB 連接線連接主機與電腦。

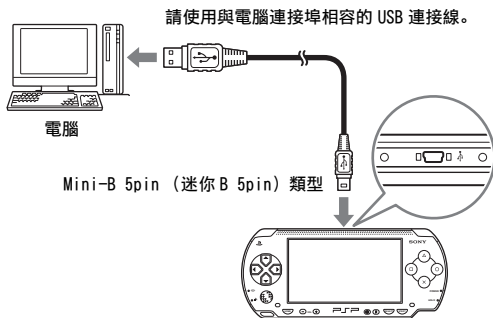

## 2 進入自家選單的 ，選擇 (USB Connection: USB 連接) 後，按下 按鈕。

電腦會主動偵測插入主機的 Memory Stick Duo™。

---

---

### 重要

請勿在電腦上進行 Memory Stick Duo™ 的格式化，否則主機可能會出現無法辨識的異常。

---

## Network Settings (網路設定)



您可調整網路設定以連線至無線區域網路 (WLAN)。本機具備兩種 WLAN 模式。

### ⚠ 警告

當您進入擁擠的火車等擁擠的場所時，請關閉無線 LAN。否則主機發出的無線電波可能會對附近的人使用之心律調整器造成不良影響。

## Ad Hoc Mode (Ad Hoc 模式)

在此模式中，您可直接與其他 PSP™ 主機通訊。若要建立 Ad Hoc 模式的通訊連線，兩部 PSP™ 皆必須設定為 "Automatic (自動)" 或設定為相同的頻道。詳細請參閱 Ad Hoc 模式對應軟件附帶的說明書。

透過 WLAN 與其他 PSP™ 主機通訊



Automatic (自動)	自動切換為最佳的通訊頻道
Ch 1 (頻道 1)、 Ch 6 (頻道 6) 或 Ch 11 (頻道 11)	使用指定頻道進行通訊

選單項目的初期預設標有下線。

## Infrastructure Mode (基礎建設模式)

在此模式中，您可利用無線基地台 (access point) 以連接 PSP™ 主機。此項設定適用於與網路連線 (▶▶ 第 216 頁) 或網路更新 (▶▶ 第 242 頁) 等功能。

## 需要準備的物品

以下為設定主機的網路連線設定與進行網路更新時，必須事先準備的物品。

- 加入網路服務商的服務
- DSL 或纜線數據機等網路裝置
- WLAN（無線基地台）或無線寬頻路由器（router）
- 一部電腦
- 基地台（SSID、WEP 鍵、WPA 鍵等特定基地台）的設定

### 提示

- 基地台是用來連線無線網路的裝置。
- SSID、WEP 與 WPA 鍵是一種無線網路資訊的類型。連線至無線基地台或路由器時可能需要使用。此類資訊一般皆是於使用電腦設定無線基地台或路由器時輸入。詳細請參閱無線基地台或路由器附帶的說明書。

## 網路設定範例

網路連線設備與設定方法可能會因使用裝備而有所不同。

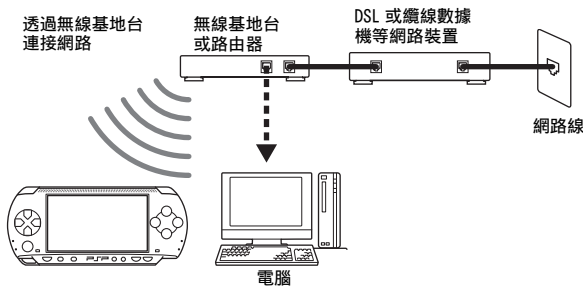

## 建立新的網路連線

您可調整網路設定以連線至無線基地台並將網路連線資料保存至主機內。最多可以保存 10 組連線資料。

- 1 進入自家選單的 ，選擇 （Network Settings: 網路設定）後，按下  按鈕。

- 選擇 "Infrastructure Mode (基礎建設模式)" 後，按下⊙按鈕。
- 選擇 "New Connection (新連線)" 後，按下⊙按鈕。
- 輸入網路連線的名稱。

在您按下⊙按鈕時，螢幕上會顯示一個鍵盤 (►►第 245 頁)，讓您輸入名稱。您可選擇您喜歡的網路連線名稱。



設定值輸入完成後，按下方向按鈕右，進入下一個畫面。

- 設定基地台的 SSID。

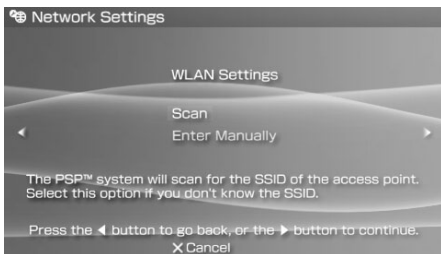

這是用來輸入下一頁列出之設定資訊的畫面。詳細請參閱無線基地台或路由器附帶的說明書。

Scan (掃描)	掃描附近的無線基地台並顯示 SSID。
Enter Manually (手動輸入)	允許用戶使用鍵盤輸入 SSID。若您知道基地台之 SSID 時，請選擇此選項。

設定值輸入完成之後，按下方向按鈕右，進入下一個畫面。

## 6 輸入基地台的加密資訊。

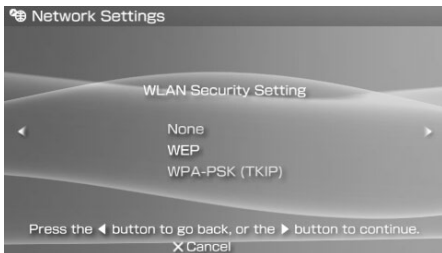

您可設定以下選項。若對您網路的必須資訊有任何疑問時，請聯絡網路服務商。

None (無)	不設定加密資訊。
WEP	設定加密資訊。請按下右按鈕，移動更換 WEP 或 WPA 鍵的輸入畫面。*
WPA-PSK (TKIP)	

\* 無論您輸入何種記號，WEP 與 WPA 鍵的位置皆只會顯示八位數的星號。

設定完成後，請按下方向按鈕之右，以進入下一個畫面。

## 7 選擇位址設定方式。

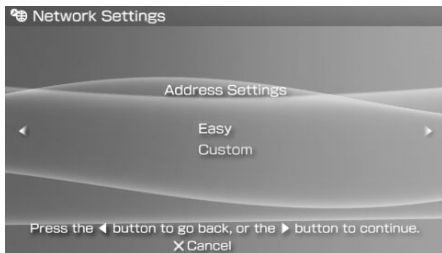

此畫面可選擇下面列示的設定。大部分家用網路皆可讓您使用 "Easy (簡易)" 設定 (建議使用的設定) 中顯示的設定。

Easy (簡易)	會自動設定下列資訊。 - IP address settings: Automatic (IP 位址設定: 自動) - DNS settings: Automatic (DNS 設定: 自動) - Proxy server: Do Not Use (代理伺服器: 不使用) - 網路瀏覽介面: 不開啟
Custom (自訂)	您可手動輸入使用固定 IP 網路等詳細設定。詳細請參閱網路裝置附帶的說明書或您的網路服務商提供的資訊。

設定值選擇完畢之後，按下方向按鈕右，進入下一個畫面。

## 8 檢查設定。

顯示詳細設定。若有必要，請按下方向按鈕左，回到前一個畫面並修改設定。

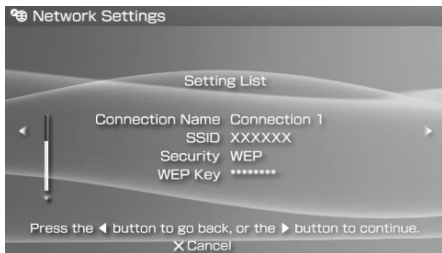

設定值選擇完畢之後，按下方向按鈕右，進入下一個畫面。

## 9 保存連線資料。

請按下  按鈕將連線資料保存至您的主機。

## 10 測試連線。

測試連線之前，請先檢查 PSP™ 主機的無線 LAN 按鈕是否已經開啟。選擇 "Test Connection (測試連線)" 後，按下  按鈕。主機便會連線至您選擇的無線基地台。

## 11 確認連線測試結果。

若連線成功，螢幕上會顯示該網路連線的相關資訊。請按下  按鈕結束連線測試。

### 提示

- 主機亦能於連接無線基地台後進行網路連線測試。網際網路的連線測試結果將同樣會顯示於連線結果畫面。
- 若連線測試失敗，請遵循畫面指示，檢查設定。您可進入選項選單，變更網路連線設定 (●▶ 第 241 頁)。詳細請參閱網路裝置附帶的使用書或您的網路服務商提供的資訊。
- 若是透過 DHCP 伺服器取得 IP 位址與 DNS 相關資訊，請於步驟 7 時設定為 "Custom (個人設定)"，則所有設定皆會被設定為 "Automatic (自動)"。
- 若您希望在與基地台連線後，自動開啟瀏覽介面，請於步驟 7 時選擇 "Custom (個人設定)"，並將 "Internet Browser (網路瀏覽介面)" 設定為 "Start (開啟)"。當遇到需透過要求於瀏覽介面執行登入的熱點遊玩線上遊戲等情形時，請選擇此項設定。
- 您可能曾因無線基地台的設定問題，而需要輸入主機的 MAC 位址以連接網路。您可進入 "System Information (系統資訊)" (●▶ 第 224 頁)，確認主機的 MAC 位址。







## 關於 DNAS

Sony Computer Entertainment Inc. 採用 DNAS (Dynamic Network Authentication System)，可幫助保護著作權與 PSP™ 主機與網路連線時的加密性。DNAS 可能會為了認證、著作權保護、帳戶阻斷、系統、規則或遊戲管理以及其他目的而自動從用戶的硬件與軟件擷取資訊。這些被擷取的資訊並不具足以識別個人的性質。各種未經認可的傳遞、公開展示、以及企圖破解認證程序的程式與裝置的進出口以及傳遞皆可能為法律所嚴禁。



## 網路設定選項選單

當選項選單顯示在 Infrastructure Mode（基礎建設模式）中時，您可編輯或刪除保存於主機的網路連線。

- 1 進入自家選單的 ，選擇  (Network Settings: 網路設定) 後，按下  按鈕。
- 2 選擇 "Infrastructure Mode（基礎建設模式）" 後，按下  按鈕。
- 3 選擇連線後，按下  按鈕。  
顯示下列的項目。請選擇您想執行的作業後，按下  按鈕。

Edit（編輯）	將網路連線設定的變更內容保存至主機*
Test Connection（測試連線）	測試與無線基地台間的連線
Delete（刪除）	刪除網路連線
Information（資訊）	顯示網路連線的相關資訊

\* 詳細的操作說明，請參閱 "建立新的網路連線"（▶▶ 第 236 頁）。

## Network Update (網路更新)

您可使用 Network Update (網路更新) 功能來更新 PSP™ 主機的系統軟件。

若您想了解更新的詳細資訊，請參閱 "PSP 更新" (▶▶ 第 247 頁)。

若欲取得最新的更新情報，請瀏覽以下網站

<http://www.sceh.com.hk> (香港、東南亞)

<http://www.sceh.com.tw> (台灣)

### 網路更新程序

#### 連接網路

利用 LAN 基地台開始連線。  
開啟 PSP™ 主機左側的無線 LAN 按鈕



#### 下載 (接收資料)

從網路下載更新資料。更新資料會被保存至插入主機的 Memory Stick Duo™。



#### 更新 (軟件更新)

使用保存於 Memory Stick Duo™ 的資料，更新系統軟件。

---

#### 重要

下載 / 更新時：





- 請勿取出 Memory Stick Duo™
- 請勿關閉主機電源
- 請勿拔下交流電轉換器

若更新被中斷，可能會導致系統軟件受損。

---

## 開始網路更新

您可使用無線基地台連接網路來下載更新資料。  
開始前，請先確定電池是否已經充飽電。





- 1** 將 Memory Stick Duo™ 插入 PSP™ 主機。
- 2** 將交流電轉換器連接至主機。  
即使您已下載了更新資料，若不連接交流電轉換器仍無法開始更新作業。
- 3** 進入自家選單的 ，選擇  (Network Update: 網路更新) 後，按下  按鈕。
- 4** 選擇連線後，按下  按鈕。  
主機將利用無線基地台連線至網路。若您並未建立並保存網路連線設定，請選擇 "New Connection (新連線)" 後按下  按鈕，以開啟設定畫面 (▶▶ 第 236 頁)。
- 5** 下載更新資料。  
連線至網路時，主機會自動掃描最新的更新資料。請遵循畫面指示，下載資料並開始更新。

### 提示

更新完成後，您即可從 Memory Stick Duo™ 刪除更新資料。

## 網路更新選項選單

顯示選項選單後，您可編輯或刪除保存於主機的網路連線。

- 1** 進入自家選單的 ，選擇  (Network Update: 網路更新) 後，按下  按鈕。
- 2** 選擇連線後，按下  按鈕。  
顯示下列的項目。請選擇您想執行的作業後，按下  按鈕。

Connect (連線)	連線至無線基地台
Edit (編輯)	將網路連線設定的變更內容保存至主機*

Delete (刪除)	刪除網路連線
Information (資訊)	顯示網路連線的相關資訊

\* 詳細的操作說明，請參閱 " 建立新的網路連線 " (►► 第 236 頁)。

# 如何使用鍵盤

您可使用畫面上顯示的鍵盤來輸入文字，以替 PSP™ 主機輸入 Nickname（暱稱），或輸入網路設定資訊等。

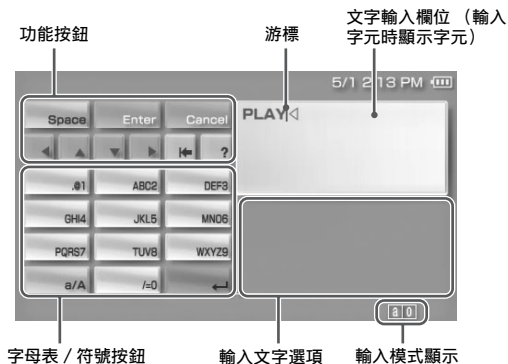





## 控制介面項目一覽表

各鍵的顯示與否將會因文字輸入狀況而異。

鍵盤按鈕	功能
Space	輸入一個空格
History	開啟網路瀏覽介面之位址輸入視窗時，將會顯示之前輸入之位址。但唯有當輸入模式設定為 "Web address shortcuts (網址捷徑列)" 時，始會顯示位址。
Enter	確認已經鍵入但尚未輸入的字元後，離開鍵盤。
Cancel	取消已經鍵入但尚未輸入的字元後，離開鍵盤。
← ↑ ↓ →	移動游標
↶	刪除游標左邊的字元
?	顯示主機之按鈕與其可執行的功能
a/A	大小寫的更換
↵	改行、移至下一行的開始位置

## 切換輸入模式

輸入模式的編號可能會因選擇語言而有所不同。每次您按下 SELECT（選擇）按鈕，都會依照下列順序變更輸入模式。







輸入模式顯示	輸入模式	您可輸入的字元範例
	字母與數字	a b c d e
	字母與數字 (含特殊字母)	é í ó ç ñ
	只有數字	1 2 3 4 5
	網址捷徑列	.com .ne .html .gif

### 提示

畫面鍵盤的設定語言乃與 System Settings（系統設定）時選擇的 System Language（系統語言）共通（▶▶第 222 頁）。若 System Language（系統語言）乃設定為日文，則此時會顯示日文鍵盤。

## 輸入字元

以下便以 "PLAY" 為範例，說明如何輸入文字。

- 1 選擇 PQRS7，並按下  按鈕數次，直到 "P" 出現為止。  
您每按下一次  按鈕，都會依照鍵上的排列順序變更鍵入文字。
- 2 選擇 JKL5，並按下  按鈕數次，直到 "L" 出現為止。
- 3 選擇 ABC2，並按下  按鈕，畫面上將顯示 "A"。
- 4 選擇 WXYZ9，並按下  按鈕數次，直到 "Y" 出現為止。
- 5 選擇 Enter 後，按下  按鈕。  
確認您輸入的字元後，再度選擇 Enter，並按下  按鈕離開鍵盤。

### 提示

於輸入字元時選擇 a/A 鍵，可選擇大小寫的更換。

## PSP™ 更新

更新 PSP™ 主機的系統軟件後，您可改變或追加機能。



您可透過下列任何一種方式，取得更新資料。

- 網路更新
- 使用電腦更新
- 使用 UMD™ 更新

選擇最適合您的更新方法。若欲取得最新的更新情報，請瀏覽以下網站：

<http://www.sceh.com.hk>（香港、東南亞）

<http://www.sceh.com.tw>（台灣）

### 網路更新

使用 PSP™ 主機的無線網路功能執行更新。詳細說明請參閱 "Network Update（網路更新）"（▶▶ 第 242 頁）。

### 使用電腦更新

使用電腦透過網路下載更新資料。詳細說明請瀏覽以下網站：

<http://www.sceh.com.hk>（香港、東南亞）

<http://www.sceh.com.tw>（台灣）

## 使用 UMD™ 更新

您可使用內含更新資料的 UMD™ 執行更新。  
開始前，請先確定電池是否已經充飽電。

### 重要

更新時：

- 請勿取出 UMD™
- 請勿關閉主機電源
- 請勿拔下交流電轉換器

若更新被中斷，可能會導致系統軟件受損。

- 1 將交流電轉換器連接至 PSP™ 主機。**  
若沒有連接交流電轉換器將無法開始更新作業。
- 2 插入內含更新資料的 UMD™。**  
於自家選單之  下，顯示了更新資料的圖示與版本序號。



- 3 選擇  後，按下  按鈕。**  
開始更新。請遵循畫面指示，完成更新。

## 確定更新是否已經成功

若「System Information (系統資訊)」( 第 224 頁) 之「System Software (系統軟件)」項目已可顯示更新資料的版本序號，即代表更新已經正確完成。



## 相容媒體

PSP™ 主機可使用下列的媒體。

於本說明書中，"Memory Stick Duo™" 一詞乃包括了所有以下列出的 Memory Stick™ 媒體。

類型	標誌
UMD™	UMD <small>UNIVERSAL MEDIA DISC</small>
Memory Stick Duo™ (不支援 MagicGate™)	<b>MEMORY STICK DUO</b>
MagicGate™ Memory Stick Duo™*1	<b>MEMORY STICK DUO MAGICGATE</b>
Memory Stick Duo™ (支援 MagicGate™) *1 *2	<b>MEMORY STICK DUO MAGICGATE</b>
Memory Stick PRO Duo™*1 *2	<b>MEMORY STICK PRO DUO MAGICGATE</b>

\*1 支援 MagicGate™

\*2 支援平行資料傳輸 (高速資料傳輸)。實際傳輸速度會因您的 Memory Stick Duo™ 相容裝置而有所不同。

### 提示

- 不保證所有 Memory Stick™ 媒體的正常動作。
- 若 Memory Stick Duo™ 乃是透過電腦等 PSP™ 以外的裝置進行格式化，則主機可能無法辨識。若遭遇此類情形，請使用 PSP™ 替 Memory Stick Duo™ 進行再格式化 (▶▶ 第 224 頁)。

## UMD™

UMD™ 具有指定銷售區域的區域碼。本主機僅適用區域碼為 "ALL" 或 "3" 的 UMD™。



## Memory Stick™

Memory Stick™ 共有兩種尺寸：標準尺寸與較小的尺寸。PSP™ 主機乃支援較小尺寸類型的 Memory Stick Duo™。本主機無法使用標準尺寸的 Memory Stick™。

### Memory Stick Duo 專用轉接卡



使用 Memory Stick Duo 專用轉接卡（型號：MSAC-M2。需另行選購之 Sony 產品）後，您即可於僅對應標準尺寸之裝置使用 Memory Stick Duo™。

### 支援 MagicGate 的 Memory Stick Duo™



為能透過瞬間的碰觸，與標準尺寸的 Memory Stick Duo™ 有所區別，支援 MagicGate 的 Memory Stick Duo™ 有一道凹凸設定（圖 **A**）。

### MagicGate

**MAGICGATE** 是 SONY 公司開發的著作權保護技術之名稱。

**MAGICGATE** 不保證與其他印有 "MagicGate" 標誌之產品間的互換相容性。

### 平行資料傳輸（高速資料傳輸）

平行資料傳輸乃是一種可同時使用 Memory Stick™ 的複數資料輸入 / 輸出端（平行介面）的高速資料傳輸技術。

## 可播放的檔案

您可使用 PSP™ 主機播放下列類型的檔案：

內容種類	檔案類型
影像	-MP4 (video codecs for video files that conform to the Memory Stick™ video file format are MPEG-4 or AVC)
音樂	-Memory Stick™ audio file format (ATRAC3™/ATRAC3plus™) -MP3 -MP4 (the audio codec for MP4 format audio files is MPEG-4 AAC) -WAV (Linear PCM)
相片	-JPEG (依循 DCF2.0/Exif2.21 規格) -TIFF -GIF -PNG -BMP

### 提示

部份資料可能因資料類型的問題而無法播放。

# 規格

本公司保留在沒有事先通知情況下，變更設定或規格之權利。

## PSP™ (PlayStation®Portable)

液晶畫面	4.3 英吋 (16:9) 全透明型 TFT 驅動 約可顯示 1,677 萬色
聲音	立體聲喇叭
內藏光碟機	唯讀 UMD™ 光碟機
介面	DC IN 5V 電源端子 充電端子 耳機 / 麥克風連接埠 紅外線連接埠 高速 USB 連接埠 DC OUT 端子 Memory Stick Duo™ 插口 Wireless LAN (無線區域網路) (IEEE 802.11b)
相容 codec	影像 -UMD™: H.264/MPEG-4 AVC Main Profile Level3 -Memory Stick™: MPEG-4 SP (MPEG-4 AAC)、H.264/MPEG-4 AVC Main Profile (MPEG-4 AAC)
	音樂 -UMD™: H.264/MPEG-4 AVC Main Profile Level 3, Linear PCM、ATRAC3plus™ -Memory Stick™: ATRAC3plus™、MP3 (MPEG1/2 Audio Layer3)、 Linear PCM (WAV 格式)、AAC (MP4 格式)
	相片 -Memory Stick™: JPEG (依循 DCF2.0/Exif2.21 規格) TIFF、GIF、PNG、 BMP
電源	交流電轉換器: DC 5.0 V 充電式電池組: 鋰離子充電式電池組
電池電力使用時間	請參閱第 171 頁

最大耗電量	約 6 W (充電時)
外觀尺寸	約 170 × 74 × 23 mm / 6 <sup>3</sup> / <sub>4</sub> × 3 × 1 in (寬 × 高 × 深) (最大凸出部分除外)
重量	約 280g (包含電池組)
操作溫度	5°C - 35°C/41°F - 95°F

## UMD™ 雷射

波長	655-665 nm
能量	最大 0.28 mW
類型	半導體, 連續性

CT

其他資訊

## 無線網路

標準	IEEE 802.11b
WEP	128-bit/64-bit
調整格式	DS-SS (依據 IEEE 802.11b 標準)

## 交流電轉換器

輸入	AC 100-240 V、50/60 Hz
輸出	DC 5 V、2000 mA
外觀尺寸	約 46 × 22 × 76 mm / 1 <sup>4</sup> / <sub>5</sub> × 4 <sup>4</sup> / <sub>5</sub> × 3 in (寬 × 高 × 深) (最大凸出部分除外)
重量	約 100g

## 電池組

電池類型	鋰離子充電式電池
電壓	DC 3.6 V
容量	1800 mAh

## 內容

請參閱第 149 頁

### ■Memory Stick Duo™

可相容之 Memory Stick Duo™:

- 支援 MagicGate™
- 可執行平行資料傳輸（高速資料傳輸）。此類高速資料傳輸只可搭配相容裝置使用。實際傳輸速度會因您使用的裝置而有所不同。
- 可用容量分為玩者實際可使用的容量以及為系統檔案預留的必要容量。本產品之玩者實際可使用容量約為 30 MB。

## 軟件

Software developed by the NetBSD Foundation, Inc. and its contributors is used for the communication functions of this product. For more information, see <http://www.scei.co.jp/psp-license/pspnet.txt>

本產品乃基於S3 Graphics, Co., Ltd.的授權而採用S3TC材質壓縮技術。

This product includes RSA BSAFE Cryptographic software from RSA Security Inc. RSA is a registered trademark of RSA Security Inc. BSAFE is a registered trademark of RSA Security Inc. in the United States and/or other countries.

U.S. and foreign patents licensed from Dolby Laboratories.

MPEG Layer-3 audio coding technology and patents licensed from Fraunhofer IIS and Thomson.

此產品附有 ACCESS 公司的 NF 瀏覽器軟體。

下文為 PSP™ 系統軟件的需注意事項。

This software is based in part on the work of the Independent JPEG Group.

Copyright © 1988-1997 Sam Leffler



Copyright © 1991-1997 Silicon Graphics, Inc.

Permission to use, copy, modify, distribute, and sell this software and its documentation for any purpose is hereby granted without fee, provided that (i) the above copyright notices and this permission notice appear in all copies of the software and related documentation, and (ii) the names of Sam Leffler and Silicon Graphics may not be used in any advertising or publicity relating to the software without the specific, prior written permission of Sam Leffler and Silicon Graphics.

THE SOFTWARE IS PROVIDED "AS-IS" AND WITHOUT WARRANTY OF ANY KIND, EXPRESS, IMPLIED OR OTHERWISE, INCLUDING WITHOUT LIMITATION, ANY WARRANTY OF MERCHANTABILITY OR FITNESS FOR A PARTICULAR PURPOSE.

IN NO EVENT SHALL SAM LEFFLER OR SILICON GRAPHICS BE LIABLE FOR ANY SPECIAL, INCIDENTAL, INDIRECT OR CONSEQUENTIAL DAMAGES OF ANY KIND, OR ANY DAMAGES WHATSOEVER RESULTING FROM LOSS OF USE, DATA OR PROFITS, WHETHER OR NOT ADVISED OF THE POSSIBILITY OF DAMAGE, AND ON ANY THEORY OF LIABILITY, ARISING OUT OF OR IN CONNECTION WITH THE USE OR PERFORMANCE OF THIS SOFTWARE.

## 商標

" " 為 Sony Computer Entertainment Inc. 之註冊商標。" " 和 "UMD" 則為該公司之商標。

" " 和 "XMB" 為 Sony Corporation 與 Sony Computer Entertainment Inc. 之商標。

"SONY" 為 Sony Corporation 之註冊商標。" " 則為該公司之商標。

"Memory Stick Duo"、"Memory Stick PRO Duo"、"Memory Stick"、" "、"SonicStage"、"MagicGate"、"ATRAC3plus" 和 "ATRAC3" 亦同為該公司之商標。

ATOK is a registered trademark of JUSTSYSTEM CORP in Japan and other countries.



Windows 為 Microsoft Corporation 在美國與其他國家之註冊商標。

Mac OS 為 Apple Computer (蘋果電腦) 在美國與其他國家之註冊商標。

所有其他商標皆屬相關著作權人所有。

## 關於國家出口控制

本產品可能因各國立法之規定而被列為限制出口商品。請嚴格遵守相關法條及任何與本產品之管轄權有關之法律規定。



## 故障檢修

在使用 PSP™ 主機時，如果操作上遭遇到困難，請閱讀下面的文章，以便找到問題的可能原因。如果仍無法解決問題，請聯絡保證書上記載的 PSP™ 消費者服務中心。

### 電源、電池以及充電

#### 無法接通電源。

- ➔ 確認電池已經充電（➔第 170 頁）。
- ➔ 確認電池組是否已正確安裝（➔第 156 頁）。

#### 無法替電池充電，或無法充飽電。

- ➔ 確認交流電轉換器與交流電源線是否已正確插入主機與電源插座。
- ➔ 確認充電時並未使用 WLAN 功能。使用 WLAN 功能時無法替電池充電。
- ➔ 確認是否使用正確的交流電轉換器。
- ➔ 確認交流電轉換器連接端是否乾淨。若出現污痕，請使用乾淨軟布輕柔擦拭。
- ➔ 若在極冷的場所充電，可能會需要較長的時間才能替電池充飽電。
- ➔ 電池組可能已經故障。請嘗試選用 PSP™ 主機專用的電池組。

#### 電池無法持久。

- ➔ 若在極熱或極冷的場所使用本主機，電池可能無法持久。請嘗試避免在類似這樣的環境中使用本主機。
- ➔ 電池組可能已經故障。請嘗試選用 PSP™ 主機專用的電池組。

#### POWER（電源）指示燈已亮起，但液晶畫面沒有顯示任何影像。

- ➔ 確認液晶畫面的背光燈是否關閉。若是，請按下任何一個按鈕，再度開啟背光燈。

---

關閉主機後，仍舊會繼續消耗電池電力。

- ➔ 即使關閉主機的電源，仍會繼續消耗電池，因此建議您經常替電池充電。

## 畫面

---

畫面突然變暗。

- ➔ 確認 Backlight Auto-Off (自動關閉背光燈) 的設定。若設定為開啟，背光燈將會於到達設定時間後自動關閉。請按下主機的任何一個按鈕，再度開啟背光燈 (•▶第 227 頁)。
- ➔ 確認 Auto Sleep (自動睡眠) 的設定。若設定為開啟，畫面將會於到達設定時間後自動變暗 (•▶第 228 頁)。

---

畫面晦暗且甚難辨識。

- ➔ 畫面可能會因觀看角度而出現忽然變暗的現象。請使用主機前面的顯示按鈕，調整畫面的亮度 (•▶第 169 頁)。

---

畫面上出現黑點、紅點、藍點與綠點且不會消失。

- ➔ 液晶畫面係使用高精密度的技術製造，但仍可能會於某些情況下，於螢幕上殘存黑點或紅點、藍點、綠點等亮點。此非故障，詳細請參閱 "使用前須知事項" (•▶第 143 頁)。

---

畫面顏色顯示不正確。

- ➔ 若 "Theme (主題)" 設定為 "Original (原始設定)"，背景顏色會於每月的第一天自動改變 (•▶第 225 頁)。本主機購買時的初期預設為 "Original (原始設定)"。

## 聲音

---

無聲。

- ➔ 確認音量是否設定為零，並嘗試提高音量 (•▶第 151、155 頁)。
- ➔ 確認是否開啟靜音設定。請按下主機前面的聲音按鈕以解除靜音設定 (•▶第 167 頁)。
- ➔ 於插入耳機時，將不會自喇叭產生任何聲音。

➔ 請參閱 " 無聲或音質低劣 " 的說明 (•▶第 262 頁)。

---

### 無法提高音量。

➔ 確認 AVLS (Automatic Volume Limiter System: 自動音量限制系統) 功能是否關閉。AVLS (Automatic Volume Limiter System: 自動音量限制系統) 功能開啟時, 會限制耳機的最高音量 (•▶第 229 頁)。

---

### 音質低劣。

➔ 若在出現震動或是靠近電視機等具有強力電磁波之物體的場所使用本主機, 聲音可能會失真且增加背景雜音。請嘗試前往其他場所使用。

---

## UMD™

---

### 主機無法辨認 UMD™。

- ➔ 確認是否已正確插入 UMD™ (標籤面朝向主機後方)。請嘗試取出 UMD™ 並重新插入。
- ➔ 確認 UMD™ 的記錄面是否乾淨。若出現污痕, 請使用乾淨軟布輕柔擦拭 (•▶第 147 頁)。

---

### 無法正常播放 UMD™。

➔ 若發生結露現象, 請自主機取出 UMD™ 並停止使用數小時, 直至水氣蒸發 (•▶第 147 頁)。

---

### 於啟動 UMD™ 時, 顯示要求更新的訊息。

➔ 更新系統軟件 (•▶第 247 頁)。

---

## Memory Stick Duo™

---

### 無法插入 Memory Stick Duo™。

➔ 確認插入時 Memory Stick Duo™ 的插入方向是否正確 (•▶第 165 頁)。

---

### 主機無法辨識 Memory Stick Duo™。

- ➔ 主機可能無法辨識利用電腦進行格式化的 Memory Stick Duo™。在將重要檔案拷貝至您的電腦後，請使用主機替此片 Memory Stick Duo™ 重新格式化。詳細請參閱 "Format Memory Stick™ (Memory Stick™ 格式化)" (•▶第 224 頁)。
- ➔ 確認是否已正確插入 Memory Stick Duo™。請嘗試取出 Memory Stick Duo™ 並重新插入。
- ➔ 確認 Memory Stick Duo™ 連接端子是否乾淨。若出現污痕，將無法正確讀取資料，請使用乾淨軟布輕柔擦拭。

---

### 主機無法保存或載入資料。

- ➔ 確認 Memory Stick Duo™ 有足夠的可用空間可保存資料 (•▶第 176 頁)。
- ➔ Memory Stick Duo™ 可能已經故障。請嘗試選用另一張 Memory Stick Duo™。

## 影像

---

### 無法操作 UMD™VIDEO。

- ➔ 若軟件製作者事先設定了播放條件，則您將可能無法手動啟動播放等功能。

---

### 沒有播放影像。

- ➔ 部份影像可能因位元率的相容性而無法於本主機上播放。請檢查該影像檔案的位元率是否為 768kbps 或更低。

---

### 主機無法辨識影像資料。

- ➔ 影像資料的檔案格式與主機不相容時，便無法正確辨識 (•▶第 251 頁)。
- ➔ 若 Memory Stick Duo™ 的檔案或資料夾名稱遭到更改，或是使用電腦將檔案或資料夾移動至其他位置，則主機將可能無法正確辨識。

### 無法播放音樂。

- ➔ 有播放期限或播放次數限制的音軌可能無法在本主機上播放。
- ➔ 播放 ATRAC3plus™ 資料時，必須使用與著作權保護功能相容的軟件將資料傳送至 Memory Stick Duo™ (●▶第 200 頁)。

### 無法播放其他群組的音軌。

- ➔ 確認 Group Mode (群組模式) 功能是否已經關閉。若開啟此功能，將只能播放一個群組內的音軌。

### 主機無法辨識音樂資料。

- ➔ 確認音樂資料是否被正確地保存於 Memory Stick Duo™ 的資料夾中 (●▶第 202 頁)。
- ➔ 音樂資料的檔案格式與主機不相容時，便無法正確辨識。 (●▶第 251 頁)。

### 無法刪除 Memory Stick Duo™ 的群組。

- ➔ 若該群組含有非音樂的資料，便無法刪除該群組。

### 無法顯示圖像。

- ➔ 部份圖像可能因資料容量過大而無法顯示。
- ➔ 曾使用 PC 編輯加工的圖像可能無法顯示。

### 主機無法辨識圖像資料。

- ➔ 確認資料是否被正確地保存於 Memory Stick Duo™ 的資料夾中 (●▶第 215 頁)。
- ➔ 若 Memory Stick Duo™ 的檔案或資料夾名稱遭到更改，或是使用電腦將檔案或資料夾移動至其他位置，則主機將可能無法正確辨識。
- ➔ 圖像與 PSP™ 主機不相容時，便無法正確辨識 (●▶第 251 頁)。

---

無法刪除 Memory Stick Duo™ 的資料夾。

- ➔ 若該群組含有非圖像的資料，便無法刪除該群組。

## 網路

---

無法建立連線。

- ➔ 確認主機左側的無線 LAN 按鈕是否已經開啟 (•▶ 第 154 頁)。
- ➔ 將 WLAN Power Save (無線區域網路省電功能) 模式設定為 Off (關閉) (•▶ 第 228 頁)，讓主機以最大電力進行連線通訊。
- ➔ 主機與基地台或主機與其他玩家之間的距離太遠。
- ➔ 確認網路連線設定 (•▶ 第 235 頁) 是否正確。詳細請參閱網路裝置附帶的使用說明書或透過您的網路服務商，建立正確的網路連線設定。
- ➔ 您可能會因基地台的設定問題而需要輸入主機的 MAC 位址 (•▶ 第 224 頁)。
- ➔ 當透過 Ad Hoc 模式與其他主機連線時，兩部主機必須設定為相同的頻道 (•▶ 第 235 頁)。

---

網頁無法正確顯示。

- ➔ 部分網頁可能無法正確顯示。

## 線控裝置與耳機

---

無聲或音質低劣。

- ➔ 確認耳機是否已完全插入主機 (•▶ 第 159 頁)。
- ➔ 確認耳機 / 麥克風連接端與耳機是否乾淨。若出現污痕，請使用乾淨軟布輕柔擦拭。並請參閱 "無聲" 的說明。

---

無法使用線控裝置操作。

- ➔ 確認耳機是否已完全插入主機 (•▶ 第 159 頁)。
- ➔ 確認線控裝置是否設定為 hold (固定) 模式。若是的話，請解除 hold (固定) 模式 (•▶ 第 155 頁)。

**主機或交流電轉換器很熱。**

- ➔ 使用時主機或交流電轉換器可能會變熱。並非故障。

**已打開主機電源卻無法操作。**

- ➔ 確認主機是否設定為 hold（固定）模式。若是的話，請向上滑動 POWER（電源）/HOLD（固定）按鈕以解除 hold（固定）模式（●▶ 第 166 頁）。
- ➔ 嘗試向上滑動 POWER（電源）/HOLD（固定）按鈕並按住不動，直到 POWER（電源）指示燈熄滅，主機完全關閉後再打開主機。

**無法正確操作主機。**

- ➔ 靜電或其他類似情況可能影響主機操作。請取出電池組與交流電轉換器，約等待 30 秒鐘後重新打開主機。

**按下按鈕時，沒有發出按鍵音。**

- ➔ 確認 Key Tone（按鍵音）功能是否已經開啟（●▶ 第 229 頁）。

**日期與時間被重新設定。**

- ➔ 若電池沒有充電且電力耗盡，或是更換了電池組，主機的日期與時間設定值便可能會被重新設定。請遵循畫面指示，設定時間與日期。

**使用 USB 連接線與電腦連接時，電腦無法辨識 PSP™ 主機。**

- ➔ 使用 USB 集線器（USB）或其他裝置時，電腦可能會因其操作環境而無法辨識插入主機的 Memory Stick Duo™。請嘗試使用 USB 連接線直接連接電腦與主機。

**您忘記了密碼。**

- ➔ 若您讓主機設定恢復為初期預設，密碼將會被重新設定為 "0000"。詳細請參閱 "Restore Default Settings（恢復預設）"（●▶ 第 224 頁）。但需注意的是當您選擇恢復預設後，密碼等其他設定都會被強制消滅。且資料一旦遺失，即無法再度尋回。

## 維修責任

請參考記載了各地區特定維修責任之相關資訊的附帶文件。









**SONY**



COMPUTER  
ENTERTAINMENT™

© 2005 Sony Computer Entertainment Inc. All rights reserved.  
Printed in Japan